

# **User's and Service Guide**

## **Agilent Technologies 85052C 3.5 mm Precision Calibration Kit**



**Agilent Part Number: 85052-90078**

**Printed in USA**

**Print Date: August 2010**

Supersedes: December 2007

© Copyright Agilent Technologies, Inc., 1994, 1995, 2000–2002, 2005, 2007, 2010

---

## Documentation Warranty

THE MATERIAL CONTAINED IN THIS DOCUMENT IS PROVIDED "AS IS," AND IS SUBJECT TO BEING CHANGED, WITHOUT NOTICE, IN FUTURE EDITIONS. FURTHER, TO THE MAXIMUM EXTENT PERMITTED BY APPLICABLE LAW, AGILENT DISCLAIMS ALL WARRANTIES, EITHER EXPRESS OR IMPLIED WITH REGARD TO THIS MANUAL AND ANY INFORMATION CONTAINED HEREIN, INCLUDING BUT NOT LIMITED TO THE IMPLIED WARRANTIES OF MERCHANTABILITY AND FITNESS FOR A PARTICULAR PURPOSE. AGILENT SHALL NOT BE LIABLE FOR ERRORS OR FOR INCIDENTAL OR CONSEQUENTIAL DAMAGES IN CONNECTION WITH THE FURNISHING, USE, OR PERFORMANCE OF THIS DOCUMENT OR ANY INFORMATION CONTAINED HEREIN. SHOULD AGILENT AND THE USER HAVE A SEPARATE WRITTEN AGREEMENT WITH WARRANTY TERMS COVERING THE MATERIAL IN THIS DOCUMENT THAT CONFLICT WITH THESE TERMS, THE WARRANTY TERMS IN THE SEPARATE AGREEMENT WILL CONTROL.

---

## DFARS/Restricted Rights Notice

If software is for use in the performance of a U.S. Government prime contract or subcontract, Software is delivered and licensed as "Commercial computer software" as defined in DFAR 252.227-7014 (June 1995), or as a "commercial item" as defined in FAR 2.101(a) or as "Restricted computer software" as defined in FAR 52.227-19 (June 1987) or any equivalent agency regulation or contract clause. Use, duplication or disclosure of Software is subject to Agilent Technologies' standard commercial license terms, and non-DOD Departments and Agencies of the U.S. Government will receive no greater than Restricted Rights as defined in FAR 52.227-19(c)(1-2) (June 1987). U.S. Government users will receive no greater than Limited Rights as defined in FAR 52.227-14 (June 1987) or DFAR 252.227-7015 (b)(2) (November 1995), as applicable in any technical data.

---

## Printing Copies of Documentation from the Web

To print copies of documentation from the Web, download the PDF file from the Agilent web site:

- Go to [www.agilent.com](http://www.agilent.com).
- Enter the product model number in the Search function and click **Search**.
- Click on the **Manuals** hyperlink.
- Open the PDF of your choice and print the document.

---

## Assistance

Product maintenance agreements and other customer assistance agreements are available for Agilent products.

For any assistance, contact Agilent Technologies. Refer to [“Contacting Agilent” on page 5-5](#).



## 1. General Information

Calibration Kit Overview	1-2
Kit Contents	1-2
Broadband Loads	1-3
Offset Opens and Shorts	1-4
Precision Adapters	1-5
Precision Airlines	1-6
Tools	1-9
3.5 mm Connectors	1-10
Calibration Definitions	1-11
Equipment Required but Not Supplied	1-11
Incoming Inspection	1-12
Recording the Device Serial Numbers	1-13
Precision Slotless Connectors	1-14
Clarifying the Terminology of a Connector Interface	1-15
Preventive Maintenance	1-15
When to Calibrate	1-16

## 2. Specifications

Environmental Requirements	2-2
Temperature—What to Watch Out For	2-2
Mechanical Characteristics	2-3
Pin Depth	2-3
Electrical Specifications	2-5
Certification	2-6

## 3. Use, Maintenance, and Care of the Devices

Electrostatic Discharge	3-2
Visual Inspection	3-3
Look for Obvious Defects and Damage First	3-3
What Causes Connector Wear?	3-3
Inspect the Mating Plane Surfaces	3-3
Inspect Female Connectors	3-4
Cleaning Connectors	3-4
Gaging Connectors	3-7
Connector Gage Accuracy	3-7
When to Gage Connectors	3-8
Gaging Procedures	3-9
Gaging Male 3.5 mm Connectors	3-9
Gaging Female 3.5 mm Connectors	3-11
Connections	3-13
How to Make a Connection	3-13
Preliminary Connection	3-13
Final Connection Using a Torque Wrench	3-13
How to Separate a Connection	3-15
Handling and Storage	3-15
Configuring Port 1 and Port 2 of the Test Setup	3-16
Installing Test Port Return Cables and Test Port Anti-Rotation Clamps	3-18
Installing Precision Adapters and Adapter Anti-Rotation Clamps	3-19

Using Precision Airlines . . . . .	3-20
When Stop Frequency Is Greater than 7 GHz . . . . .	3-20
When Start Frequency Is Less Than 7 GHz . . . . .	3-23
Performing a TRL 2-Port Calibration for a Coaxial Device Measurement . . . . .	3-26
PNA-Series Network Analyzers . . . . .	3-26
872x-Series and 875x-Series Network Analyzers. . . . .	3-27
8510-Series Network Analyzers . . . . .	3-27
Load Calibration Kit Definition . . . . .	3-27
Measure Standards. . . . .	3-27
Check the Calibration. . . . .	3-30
Adapter Removal Calibration . . . . .	3-32
General Theory. . . . .	3-32
Noninsertable Device Configurations . . . . .	3-32
Adapter Removal Calibration Procedure . . . . .	3-33
Offset Load Calibration. . . . .	3-35
Offset Load Calibration Sequence for the PNA . . . . .	3-36
Procedure A: Female Test Port on DUT . . . . .	3-36
Procedure B: Male Test Port on DUT . . . . .	3-39
<b>4. Performance Verification</b>	
Introduction . . . . .	4-2
How Agilent Verifies the Devices in Your Kit . . . . .	4-2
Recertification . . . . .	4-3
How Often to Recertify. . . . .	4-3
Where to Send a Kit for Recertification . . . . .	4-3
<b>5. Troubleshooting</b>	
Troubleshooting Process . . . . .	5-2
Where to Look for More Information . . . . .	5-3
Returning a Kit or Device to Agilent . . . . .	5-4
Contacting Agilent. . . . .	5-5
<b>6. Replaceable Parts</b>	
Introduction . . . . .	6-2
<b>A. Standard Definitions</b>	
Class Assignments and Standard Definitions Values are Available on the Web. . . . .	A-2

---

# **1 General Information**

## Calibration Kit Overview

The Agilent 85052C 3.5 mm calibration kit is used to calibrate Agilent network analyzers up to 32 GHz for measurements of components with 3.5 mm connectors.

The 85052C is designed to be used in TRL 2-Port measurement calibration as implemented in vector network analyzers. TRL stands for Thru-Reflect-Line, naming the main standards used in the accuracy enhancement procedure.

The 3.5 mm connector is the most frequently used connector for frequency coverage up to 32 GHz. Well constructed 3.5 mm connectors and transmission lines can work up to 34 GHz. Metrology grade versions of this connector are used for high performance test ports and for calibration standards. All 3.5 mm female connectors are of the precision slotless (PSC-3.5) type. These connectors are designed for long repeatability when used with appropriate connector care and connection technique. SMA, SMA-compatible, or 3.5 mm connectors used on the test ports, adapters, cables, and calibration standards provide the most accurate and repeatable measurements.

TRL (Thru-Reflect-Line) represents a family of calibration techniques that measure various combinations of precision transmission lines and reflection standards to determine the 2-Port, 12-term VNA error coefficients. The specific calibration techniques described here use measurements of the zero-length thru (T), reflection standards (R) at each port, and one or more lengths of precision transmission line (L) of the same impedance to cover the desired calibration frequency range. At low frequencies where the required transmission line length becomes too long for precision work, the TRM (thru-reflect-match) calibration is used. The fixed loads in the kit are used as matched standards.

The 85052C calibration kit can also be used to perform 1-port calibrations using the open-short-load (OSL) and open-short-offset load techniques. The precision transmission lines can be used as precision offsets for the offset load calibrations.

## Kit Contents

The 85052C 3.5 mm Precision Calibration Kit contains components useful for several different calibration techniques. The parts used for the TRL 2-Port calibration are:

- longer precision air line for 2 to 7 GHz
- shorter precision air line for 7 to 32 GHz
- male and female short circuits
- male and female open circuits
- male and female fixed loads

Other parts included are:

- three precision TRL adapters
- two adapter anti-rotation clamps
- airline insertion tools
- 5/16 inch, 90 N-cm (8 in-lb) torque wrench



- spanner wrench
- 4-mm hex balldriver
- calibration kit storage case

Refer to [Chapter 6, “Replaceable Parts,”](#) for a complete list of kit contents and their associated part numbers.

## Broadband Loads

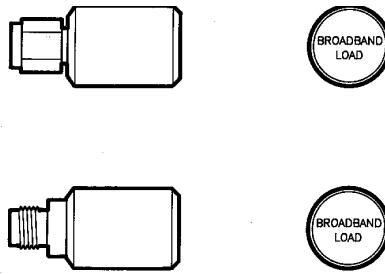
The broadband loads are metrology-grade terminations that have been optimized for performance up to 26.5 GHz. The rugged internal structure provides for highly repeatable connections. A distributed resistive element on sapphire provides excellent stability and return loss.

TRL 2-Port calibration allows measurement of the loads to determine the error coefficients. The default usage is TRM up to 2 GHz. It may be used up to 26.5 GHz by changing the calibration kit definitions. The “match” standards may be defined as infinite-length transmission lines whose input impedance is the reference impedance,  $Z_0$ . They may be defined as loads also. See Agilent Application Note 1287-11 (Agilent part number 5989-4840EN), “Specifying Calibration Standards and Kits for Agilent Vector Network Analyzers.” You can view this document online at [www.agilent.com](http://www.agilent.com) by using the search function.

When the more accurate OSL calibration is desired, the broadband loads, in conjunction with the precision transmission lines and adapters, can be used in the offset load configuration. See [“Offset Load Calibration” on page 3-35](#). An offset load can be considered a compound standard consisting of two known offsets (transmission lines) of different length and a load element. The definition of the offsets is the same as all offset transmission lines. The shorter of the two offsets can be a zero length offset. The load element is defined as a one-port reflection standard. An offset load standard is used when the response of the offset standards is known more precisely than the response of the load element. Measurement of an offset load standard consists of two measurements - both offsets terminated by the load element. The frequency range of the offset load standard should be set so that there will be at least a 20-degree separation between the expected response of each measurement. In cases where more than two offsets are used, the frequency range may be extended. This is because the internal algorithm at each frequency will search through all of the possible combinations of offsets to find the pair with the widest expected separation (to use in determining the actual response of the load element.) When specifying more than two offsets, the user should define multiple offset load standards.

These same broadband loads are used for the isolation part of the calibration. Exact equivalent responses are not required for this step.

**Figure 1-1 0 to 26.5 GHz Loads — Male and Female Fixed Broadband Loads**



### **Offset Opens and Shorts**

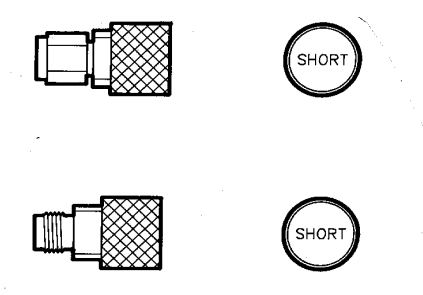
The offset opens and shorts are built from parts that are machined to the current state-of-the-art in precision machining.

The offset short's inner conductors have a one-piece construction, common with the shorting plane. The construction provides for extremely repeatable connections.

The offset opens have inner conductors that are supported by a strong, low-dielectric-constant plastic to minimize compensation values.

Both the opens and shorts are constructed so that the pin depth can be controlled very tightly, thereby minimizing phase errors. The lengths of the offsets in the opens and shorts are designed so that the difference in phase of their reflection coefficients is approximately 180 degrees at all frequencies.

**Figure 1-2 Reflection Standards — Male and Female Short Circuits**



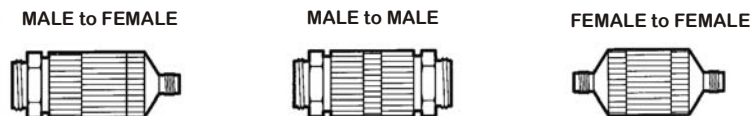
### Precision Adapters

Like the other devices in the kit, the precision adapters are built to very tight tolerances to provide good broadband performance. The adapters utilize a dual-beaded connector structure to ensure stable, repeatable connections. The beads are designed to minimize return loss and are separated far enough so that interaction between the beads is minimized.

The precision adapters are designed so that their nominal electrical lengths are the same, which allows them to be used in calibration procedures for non-insertable devices.

Three precision adapters are included in this kit. Two are always recommended for the 3.5 mm TRL 2-Port measurement calibration. All three can be used with the 8510-series, 872x-series, and 875x-series network analyzers in the adapter removal calibration for measurement of noninsertable devices. (The PNA offers calibrations for non-insertable devices that are more accurate than the adapter removal method.) Complete performance verification assumes use of the precision adapters in this kit as the test ports.

**Figure 1-3 Precision TRL Test Port Adapters**



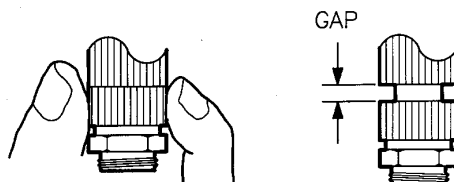
**Recession Limits** The female receptacle recession and the male pin recession, along with other mechanical specifications of Port 1 and Port 2, must be within limits to meet complete measurement specifications. If other connectors than these precision adapters are used as the test ports, they must be fully inspected. Using other than the highest quality connectors as the test ports will reduce accuracy and repeatability as well as possibly damaging the calibration standards.

**Precision Connectors** For general use, any 3.5 mm precision slotless female connector can be used for the female test port. The 3.5 mm precision male connector used on the male end of these adapters is always required for measurements between 7-32 GHz in order to connect the 7-32 GHz air line in this kit. Any 3.5 mm precision male connector can be used at frequencies less than 7 GHz.

**Installation Feature** The precision adapter male connector has a special feature to allow installation of the 7-32 air line.

- Grasp the knurled sleeve and move the nut to its extended position by pulling on it. This is the position used for measurement of the 7-32 GHz air line.

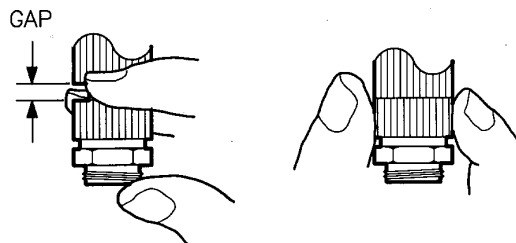
**Figure 1-4 Extended Position**



- Now move the sleeve forward and push the nut back into its standard position.

This position is used to install the 2-7 GHz air line, for connecting the other calibration standards, and for connecting the device under test.

**Figure 1-5 Standard Position**



### Precision Airlines

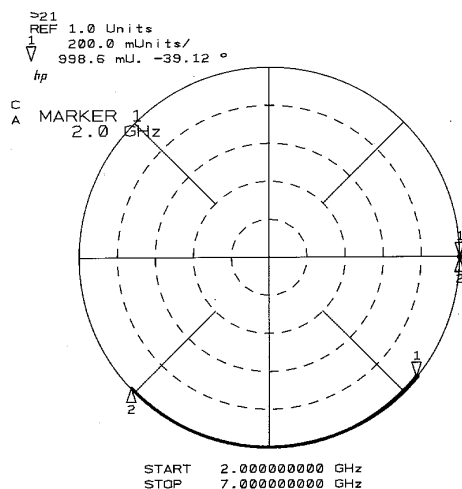
The precision airlines are metrology-grade impedance reference devices. The characteristic impedance ( $Z_0$ ) of the line establishes the reference impedance after error correction is applied. Each airline is always stored in its installation tool to help prevent damage and preserve cleanliness.

The shorter air line is used for measurement calibration over the 7 to 32 GHz frequency range. The longer air line is used for measurement calibration over the 2 to 7 GHz range. Each air line is fully specified at all frequencies within its stated range.

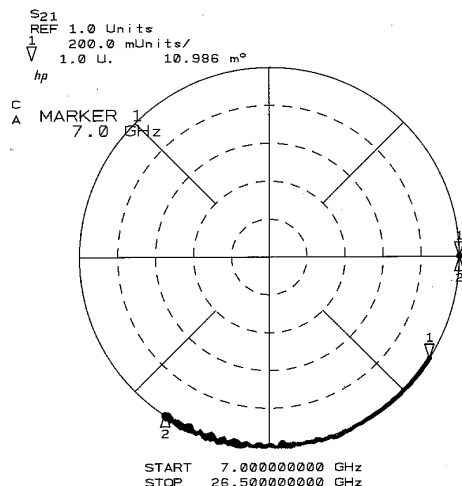
**Figure 1-6 Line Standards — 7 to 32 GHz and 2 to 7 GHz Air Lines Installed in Tools with Storage Bottles**



**Figure 1-7 Polar Display Showing Phase Response of Longer Air Line Over 2 to 7 GHz Frequency Range**

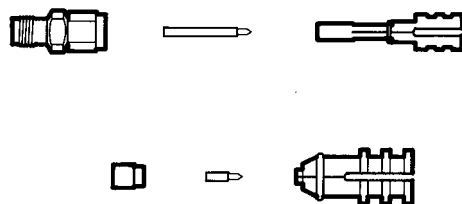


**Figure 1-8 Polar Display Showing Phase Response of Shorter Air Line Over 7 to 26.5 GHz Frequency Range**



Each air line consists of a separate outer conductor and center conductor and includes its own tool used for installing and removing the parts from the test port. Both are insertable. Each has a male end and a female end. The male end of the air line fits into the installation tool.

**Figure 1-9 Air Lines Removed from Installation Tools**

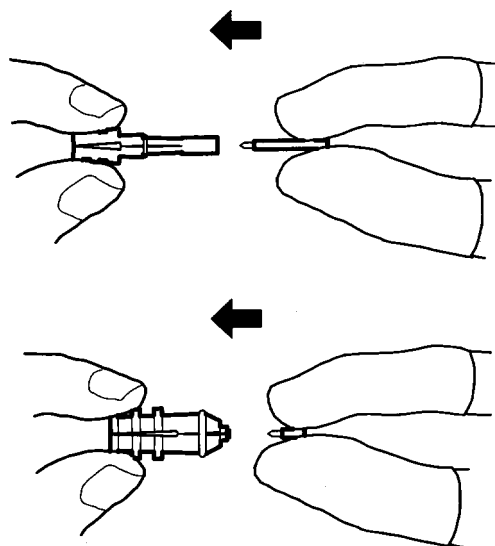


---

**CAUTION** The parts may be removed for inspection, if necessary. The tool is always used to install the parts for calibration. Use extreme care in handling these parts. Use static dissipative finger sheaths, or "finger cots," to prevent contamination. Liquid or solid residue on the connector parts will degrade performance. In particular, the inner conductors can be easily deformed by squeezing. Do not use metal tweezers or other devices to pick up or hold the parts.

---

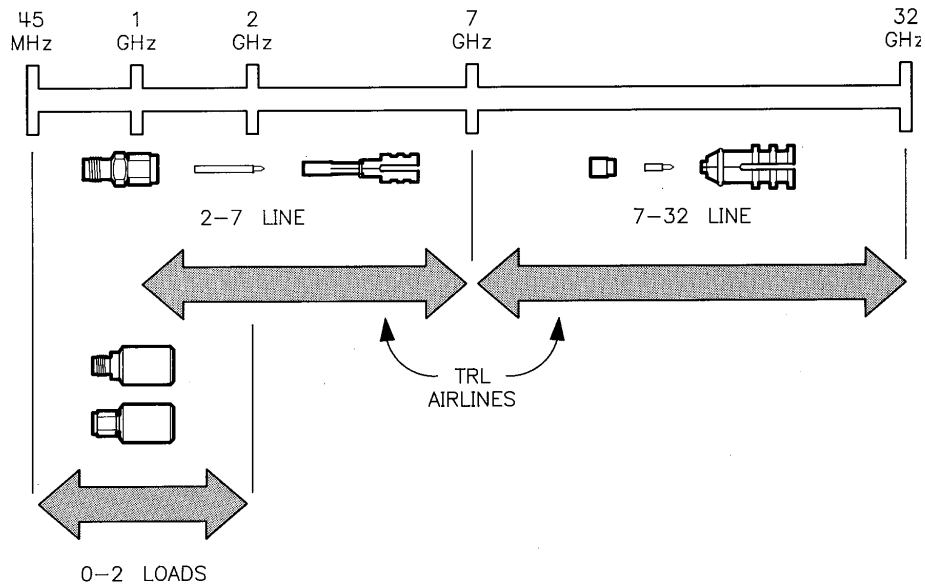
**Figure 1-10 Installing the Air Lines in Installation Tools**



**Air Line Frequency Coverage** The following illustration shows the frequency range covered by the air line and fixed loads for the Lines part of the TRL 2-Port calibration procedure. If measuring over the entire frequency range, measure the 7-32 Line first, then the 2-7 Line, then the 0-2 Loads. If measuring over a reduced frequency range, only those standards for that frequency range need to be measured. For example, if you are testing over the 3-22 GHz range, only the 7-32 Line and the 2-7 Line must be measured.

The standard label for the 2-7 Line would indicate that its data is valid only from 2 to 7 GHz. However, you may choose to use data from the 2-7 Line down to the 1 GHz by simply not measuring the 0-2 Loads. If the 0-2 Loads are measured after the 2-7 Line, the 0-2 Loads data will replace data from the 2-7 Line.

**Figure 1-11 Frequency Coverage for Line Part of Measurement Calibration**



**Changing the Air Line Frequency Range** Sometimes your application may require a frequency range slightly beyond the standard frequency range of one of the precision air lines. In this case, you may extend the frequency range of one of the air lines in order to accomplish the calibration by connecting only one of the air lines.

The error coefficients are determined with best accuracy when the Thru and the Line phase response is separated by  $\pm 90$  degrees at corresponding frequencies. When the transmission phase response of a line standard is the same or gets very close to zero or 180 degrees of the Thru standard at the same frequency, the result becomes less certain. The correct result cannot be determined when the phase response is exactly equal or 180 degrees apart. This is why a particular length air line covers a specific frequency range.

To evaluate the phase response, first do a simple transmission frequency response calibration using the Thru standard (Port 1 connected directly to Port 2), then measure the  $S_{21}$  phase of the air line. The standard air line frequency specifications provide for greater than 20 degrees separation.

Experiment with this by using the Modify Cal Kit function to change the Minimum Frequency or Maximum Frequency specification for the air line, and then performing the TRL 2-Port calibration procedure. With correction on, the trace noise on the error-corrected trace may increase at the points where the phase of the air line used for calibration approaches the phase of the Thru, often showing large discontinuities at the point where the phase of both standards are identical or separated by 180 degrees.

If this error is acceptable in your measurement, change the standard label for the air line and save the redefined cal kit for later use. If the error is not acceptable, reload the standard cal kit definition.

### Tools

A torque wrench and spanner wrench are included in the kit to loosen and tighten the

connectors. The small torque wrench is used for the 3.5-mm nuts. The large torque wrench is used for the 20-mm nuts on the precision adapters. It is included with the network analyzer. The spanner wrench is used to hold the precision adapter while using the appropriate torque wrench to tighten the connection.

Also included is the hex wrench for tightening and loosening the adapter anti-rotation clamp securing screws.

---

**CAUTION** When making connections, turn the nut on the device; never turn the device itself. Turning the device will cause excessive wear of both connector mating surfaces and cause debris to collect in the female receptacle.

---

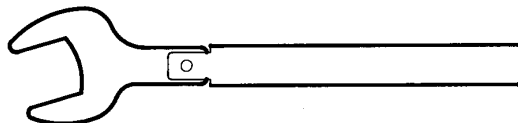
**Figure 1-12 Torque Wrench**



**Figure 1-13 Spanner Wrench**



**Figure 1-14 Torque Wrench (not included)**



**Figure 1-15 Hex Wrench for Adapter Anti-Rotation Clamp**



### 3.5 mm Connectors

The 3.5 mm geometry connector is the most frequently used connector when frequency coverage up to 26.5 GHz, reasonable commonality, and durability is desired. Well constructed connectors and transmission lines can work up to 34 GHz. Metrology grade versions of this connector are used for high performance test ports and for calibration standards. Whether the device uses SMA, SMA-compatible, or 3.5 mm, the 3.5 mm connectors used on the test ports, adapters, cables, and calibration standards provide the most accurate and repeatable solution.



## Calibration Definitions

The calibration kit must be selected and the calibration definitions for the devices in the kit installed in the network analyzer prior to performing a calibration.

The calibration definitions can be:

- resident within the analyzer
- manually entered from the front panel

Class assignments and standard definitions may change as more accurate model and calibration methods are developed. You can download the most recent class assignments and standard definitions from Agilent's Calibration Kit Definitions Web page at [www.na.tm.agilent.com/pna/caldefs/stddefs.html](http://www.na.tm.agilent.com/pna/caldefs/stddefs.html)

Refer to your network analyzer user's guide or embedded Help for instructions on manually entering calibration definitions, selecting the calibration kit, and performing a calibration.

---

**NOTE** The 8510 network analyzer is no longer being sold or supported by Agilent. However, you can download the 8510 class assignments and standard definitions from Agilent's Calibration Kit Definitions Web page at [www.na.tm.agilent.com/pna/caldefs/stddefs.html](http://www.na.tm.agilent.com/pna/caldefs/stddefs.html)

---

## Equipment Required but Not Supplied

Gages, connector cleaning supplies, test port anti-rotation clamps, and various electrostatic discharge (ESD) protection devices are not supplied with the calibration kit but are required to ensure successful operation of the kit. Refer to [Table 6-2 on page 6-4](#) for ordering information.

## Incoming Inspection

Verify that the shipment is complete by referring to [Table 6-1 on page 6-2](#).

Check for damage. The foam-lined storage case provides protection during shipping. Verify that this case and its contents are not damaged.

If the case or any device appears damaged, or if the shipment is incomplete, contact Agilent Technologies. See [page 5-5](#) for contact information. Agilent will arrange for repair or replacement of incomplete or damaged shipments without waiting for a settlement from the transportation company.

When you send the kit or device to Agilent, include a service tag (found at the back of this manual) with the following information:

- your company name and address
- the name of a technical contact person within your company, and the person's complete phone number
- the model number and serial number of the kit
- the part number and serial number of the device
- the type of service required
- a *detailed* description of the problem

## Recording the Device Serial Numbers

In addition to the kit serial number, the devices in the kit are individually serialized (serial numbers are labeled onto the body of each device). Record these serial numbers in [Table 1-1](#). Recording the serial numbers will prevent confusing the devices in this kit with similar devices from other kits.

The adapters included in the kit are for measurement convenience only and are not serialized.

**Table 1-1 Serial Number Record for the 85052C**

Device	Serial Number
<b>Calibration kit</b>	
–m– broadband load	
–f– broadband load	
–m– open	
–f– open	
–m– short	
–f– short	
–m– to –m– precision adapter	
–m– to –f– precision adapter	
–f– to –f– precision adapter	
Long precision airline (2 to 7 GHz)	
Short precision airline (7 to 32 GHz)	

## Precision Slotless Connectors

The female 3.5 mm connectors in this calibration kit are metrology-grade, precision slotless connectors (PSC). A characteristic of metrology-grade connectors is direct traceability to national measurement standards through their well-defined mechanical dimensions.

*Conventional* female center conductors are slotted. When mated, the female center conductor is flared by the male pin. Because physical dimensions determine connector impedance, electrical characteristics of the female connector (and connection pair) are dependent upon the mechanical dimensions of the male pin. While connectors are used in pairs, their male and female halves are always specified separately as part of a standard, instrument, or device under test. Because of these facts, making precision measurements with the conventional slotted connector is very difficult, and establishing a direct traceability path to primary dimensional standards is nearly impossible.

The precision slotless connector was developed to eliminate these problems. All PSCs are female. A PSC incorporates a center conductor with a solid cylindrical shell that defines the outside diameter of the female center pin. Its outside diameter and, therefore, the impedance in its region does not change. The inner part provides an internal contact that flexes to accept the allowed range of male pin diameters.

The calibration of a network analyzer having a conventional slotted female connector on the test port remains valid only when the device under test and all calibration standards have identical male pin diameters. For this reason PSC test port adapters are supplied in most calibration kits.

Precision slotless connectors have the following characteristics:

- There is no loss of traceable calibration on test ports when the male pin diameter of the connector on the device under test is different from the male pin diameter of the calibration standard.
- The female PSC and its mating male connector can be measured and specified separately as part of the device either is attached to.
- All female connectors can have a known, stable impedance based only on the diameters of their inner and outer conductors.
- Female calibration standards can be fully specified. Their specifications and traceability are unaffected by the diameter of the male mating pin.
- A fully traceable performance verification is made using a precision 50 ohm airline having a PSC.
- Measurement repeatability is enhanced due to non-changing connector characteristics with various pin diameters.

With PSCs on test ports and standards, the percentage of accuracy achieved when measuring at 50 dB return loss levels is comparable to using conventional slotted connectors measuring devices having only 30 dB return loss. This represents an accuracy improvement of about 10 times.

---

## Clarifying the Terminology of a Connector Interface

In this document and in the prompts of the PNA calibration wizard, the gender of cable connectors and adapters is referred to in terms of the center conductor. For example, a connector or device designated as 1.85 mm –f– has a 1.85 mm female center conductor.

**8510-series, 872x, and 875x ONLY:** In contrast, during a measurement calibration, the network analyzer softkey menus label a 1.85 mm calibration device with reference to the sex of the analyzer’s test port connector—not the calibration device connector. For example, the label SHORT (F) refers to the short that is to be connected to the female test port. This will be a male short from the calibration kit.

**Table 1-2 Clarifying the Sex of Connectors: Examples**

Terminology	Meaning
Short –f–	Female short (female center conductor)
Short (f)	Male short (male center conductor) to be connected to female port

A connector gage is referred to in terms of the connector that it measures. For instance, a male connector gage has a female connector on the gage so that it can measure male devices.

---

## Preventive Maintenance

The best techniques for maintaining the integrity of the devices in the kit include:

- routine visual inspection
- cleaning
- proper gaging
- proper connection techniques

All of these are described in [Chapter 3](#). Failure to detect and remove dirt or metallic particles on a mating plane surface can degrade repeatability and accuracy and can damage any connector mated to it. Improper connections, resulting from pin depth values being out of the observed limits (see [Table 2-2 on page 2-4](#)) or from bad connection techniques, can also damage these devices.

## When to Calibrate

A network analyzer calibration remains valid as long as the changes in the systematic error are insignificant. This means that changes to the uncorrected leakages (directivity and isolation), mismatches (source match and load match), and frequency response of the system are small (<10%) relative to accuracy specifications.

Change in the environment (especially temperature) between calibration and measurement is the major cause in calibration accuracy degradation. The major effect is a change in the physical length of external and internal cables. Other important causes are dirty and damaged test port connectors and calibration standards. If the connectors become dirty or damaged, measurement repeatability and accuracy is affected.

Fortunately, it is relatively easy to evaluate the general validity of the calibration. To test repeatability, remeasure one of the calibration standards. If you can not obtain repeatable measurements from your calibration standards, maintenance needs to be performed on the test port connectors, cables and calibration standards. Also, maintain at least one sample of the device under test or some known device as your reference device. A verification kit may be used for this purpose. After calibration, measure the reference device and note its responses. Periodically remeasure the device and note any changes in its corrected response which can be attributed to the test system. With experience you will be able to see changes in the reference responses that indicate a need to perform the measurement calibration again.

---

## **2 Specifications**

---

## Environmental Requirements

**Table 2-1 Environmental Requirements**

Parameter	Limits
Temperature	
Operating <sup>a</sup>	+20 °C to +26 °C
Storage	–40 °C to +75 °C
Error-corrected range <sup>b</sup>	± 1 °C of measurement calibration temperature
Relative humidity	Type tested, 0% to 95% at 40 °C, non-condensing

- a. The temperature range over which the calibration standards maintain conformance to their specifications.
- b. The allowable network analyzer ambient temperature drift during measurement calibration and during measurements when the network analyzer error correction is turned on. Also, the range over which the network analyzer maintains its specified performance while correction is turned on.

### Temperature—What to Watch Out For

Changes in temperature can affect electrical characteristics. Therefore, the operating temperature is a critical factor in performance. During a measurement calibration, the temperature of the calibration devices must be stable and within the range shown in [Table 2-1](#).

---

**IMPORTANT** Avoid unnecessary handling of the devices during calibration because your fingers are a heat source.

---



## Mechanical Characteristics

Mechanical characteristics such as center conductor protrusion and pin depth are *not* performance specifications. They are, however, important supplemental characteristics related to electrical performance. Agilent Technologies verifies the mechanical characteristics of the devices in the kit with special gaging processes and electrical testing. This ensures that the device connectors do not exhibit any center conductor protrusion or improper pin depth when the kit leaves the factory.

“Gaging Connectors” on page 3-7 explains how to use gages to determine if the kit devices have maintained their mechanical integrity. Refer to Table 2-2 on page 2-4 for typical and observed pin depth limits.

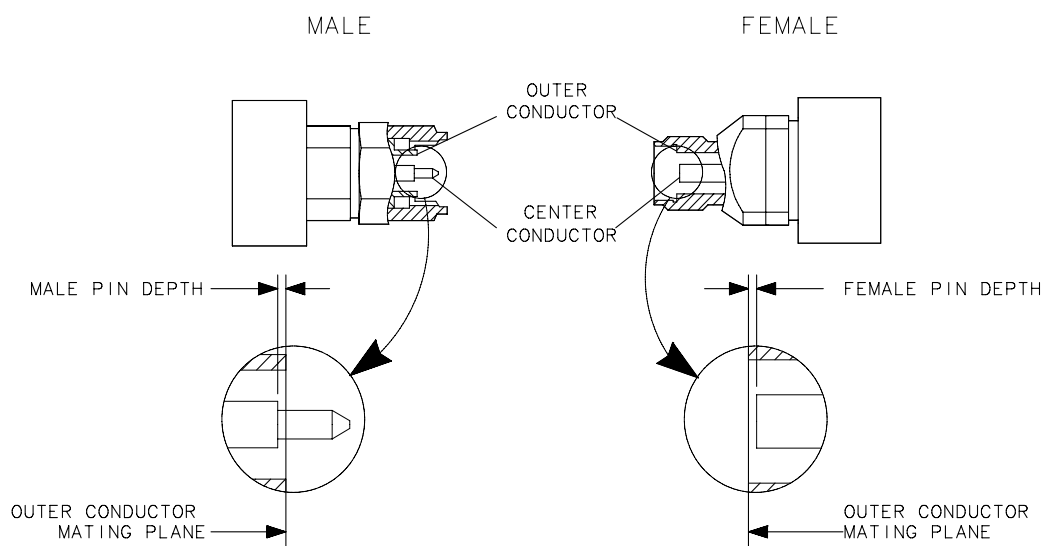
### Pin Depth

Pin depth is the distance the center conductor mating plane differs from being flush with the outer conductor mating plane. See Figure 2-1. The pin depth of a connector can be in one of two states: either protruding or recessed.

**Protrusion** is the condition in which the center conductor extends beyond the outer conductor mating plane. This condition will indicate a positive value on the connector gage.

**Recession** is the condition in which the center conductor is set back from the outer conductor mating plane. This condition will indicate a negative value on the connector gage.

**Figure 2-1 Connector Pin Depth**



wj63d

The pin depth value of each calibration device in the kit is not specified, but is an important mechanical parameter. The electrical performance of the device depends, to some extent, on its pin depth. The electrical specifications for each device in the kit take into account the effect of pin depth on the device’s performance. [Table 2-2](#) lists the typical pin depths and measurement uncertainties, and provides observed pin depth limits for the devices in the kit. If the pin depth of a device does not measure within the *observed* pin depth limits, it may be an indication that the device fails to meet electrical specifications. Refer to [Figure 2-1](#) for a visual representation of proper pin depth (slightly recessed).

**Table 2-2 Pin Depth Limits**

Device	Typical Pin Depth	Measurement Uncertainty <sup>a</sup>	Observed Pin Depth Limits <sup>b</sup>
Opens	0 to -0.0127 mm 0 to -0.00050 in	+0.0064 to -0.0064 mm +0.00025 to -0.00025 in.	+0.0064 to -0.0191 mm +0.00025 to -0.00075 in
Shorts	0 to -0.0127 mm 0 to -0.00050 in	+0.0041 to -0.0041 mm +0.00016 to -0.00016 in	+0.0041 to -0.0168 mm +0.00016 to -0.00066 in
Fixed loads	-0.0025 to -0.0254 mm -0.0001 to -0.00100 in	+0.0041 to -0.0041 mm +0.00016 to -0.00016 in	+0.0016 to -0.0295 mm +0.00006 to -0.00116 in
TRL adapter (test port end)	0 to -0.0508 mm 0 to -0.00020 in	+0.0041 to -0.0041 mm +0.00016 to -0.00016 in	+0.0041 to -0.0549 mm +0.00016 to -0.00036 in
TRL Adapter (airline end)	0 to -0.0051 mm 0 to -0.00020 in	+0.0041 to -0.0041 mm +0.00016 to -0.00016 in	+0.0041 to -0.0091 mm +0.00016 to -0.00036 in

- a. Approximately +2 sigma to -2 sigma of gage uncertainty based on studies done at the factory according to recommended procedures.
- b. Observed pin depth limits are the range of observation limits seen on the gage reading due to measurement uncertainty. The depth could still be within specifications.

## Electrical Specifications

The electrical specifications in [Table 2-3](#) apply to the devices in your calibration kit when connected with an Agilent precision interface.

**Table 2-3 Electrical Specifications for 85052C 3.5 mm Devices**

Device	Specification	Frequency (GHz)
Broadband loads (male and female)	Return loss $\geq 46$ dB ( $\rho \leq 0.00501$ ) <sup>a</sup>	dc to $\leq 2$
	Return loss $\geq 44$ dB ( $\rho \leq 0.00631$ )	$> 2$ to $\leq 3$
	Return loss $\geq 38$ dB ( $\rho \leq 0.01259$ )	$> 3$ to $\leq 8$
	Return loss $\geq 36$ dB ( $\rho \leq 0.01585$ )	$> 8$ to $\leq 20$
	Return loss $\geq 34$ dB ( $\rho \leq 0.01995$ )	$> 20$ to $\leq 26.5$
Offset opens <sup>b</sup> (male and female)	$\pm 0.65^\circ$ deviation from nominal	dc to $\leq 3$
	$\pm 1.20^\circ$ deviation from nominal	$> 3$ to $\leq 8$
	$\pm 2.00^\circ$ deviation from nominal	$> 8$ to $\leq 20$
	$\pm 2.00^\circ$ deviation from nominal	$> 20$ to $\leq 26.5$
Offset shorts <sup>b</sup> (male and female)	$\pm 0.50^\circ$ deviation from nominal	dc to $\leq 3$
	$\pm 1.00^\circ$ deviation from nominal	$> 3$ to $\leq 8$
	$\pm 1.75^\circ$ deviation from nominal	$> 8$ to $\leq 20$
	$\pm 1.75^\circ$ deviation from nominal	$> 20$ to $\leq 26.5$
Long precision airline <sup>c</sup>	Return loss $\geq 56$ dB ( $\rho \leq 0.00158$ )	$> 2$ to $\leq 7$
Short precision airline <sup>c</sup>	Return loss $\geq 50$ dB ( $\rho \leq 0.00316$ )	$> 7$ to $\leq 26.5$
Precision adapters	Return loss $\geq 30$ dB ( $\rho \leq 0.0316$ )	dc to $\leq 2$
	Return loss $\geq 27$ dB ( $\rho \leq 0.0447$ )	$> 2$ to $\leq 3$

- a. Broadband load characteristics  $\leq 2$  GHz are used only for TRL 2-port calibrations. 1-port calibrations use broadband load characteristics in the 45 MHz to 26.5 GHz frequency range.
- b. The specifications for the opens and shorts are given as allowed deviation from the nominal model as defined in the standard definitions.
- c. The specifications for the airlines is based on mechanical measurements. Refer to the calibration report included with you kit for the exact dimensions of your precision airlines. The values given in the calibration report take precedence over any other published values.

## Certification

Agilent Technologies certifies that this product met its published specifications at the time of shipment from the factory. Agilent further certifies that its calibration measurements are traceable to the United States National Institute of Standards and Technology (NIST) to the extent allowed by the institute's calibration facility, and to the calibration facilities of other International Standards Organization members. See [“How Agilent Verifies the Devices in Your Kit” on page 4-2](#) for more information.

---

## **3 Use, Maintenance, and Care of the Devices**

## Electrostatic Discharge

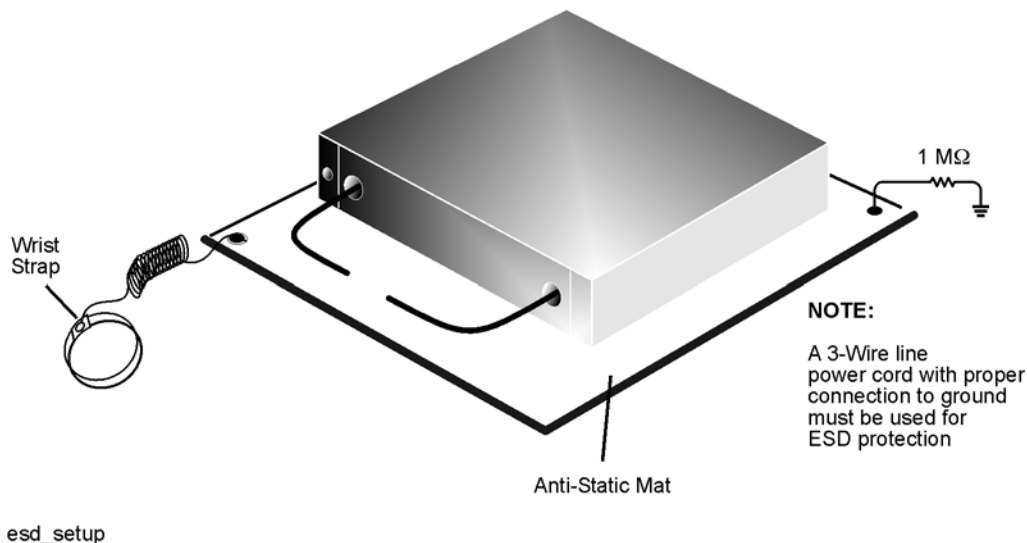
Protection against electrostatic discharge (ESD) is essential while connecting, inspecting, or cleaning connectors attached to a static-sensitive circuit (such as those found in test sets).

Static electricity can build up on your body and can easily damage sensitive internal circuit elements when discharged. Static discharges too small to be felt can cause permanent damage. Devices such as calibration components and devices under test (DUT), can also carry an electrostatic charge. To prevent damage to the test set, components, and devices:

- *always* wear a grounded wrist strap having a 1 M $\Omega$  resistor in series with it when handling components and devices or when making connections to the test set.
- *always* use a grounded, conductive table mat while making connections.
- *always* wear a heel strap when working in an area with a conductive floor. If you are uncertain about the conductivity of your floor, wear a heel strap.
- *always* ground yourself before you clean, inspect, or make a connection to a static-sensitive device or test port. You can, for example, grasp the grounded outer shell of the test port or cable connector briefly.
- *always* ground the center conductor of a test cable before making a connection to the analyzer test port or other static-sensitive device. This can be done as follows:
  1. Connect a short (from your calibration kit) to one end of the cable to short the center conductor to the outer conductor.
  2. While wearing a grounded wrist strap, grasp the outer shell of the cable connector.
  3. Connect the other end of the cable to the test port.
  4. Remove the short from the cable.

Figure 3-1 shows a typical ESD protection setup using a grounded mat and wrist strap. Refer to Table 6-2 on page 6-4 for information on ordering supplies for ESD protection.

**Figure 3-1 ESD Protection Setup**



## Visual Inspection

Visual inspection and, if necessary, cleaning should be done every time a connection is made. Metal particles from the connector threads may fall into the connector when it is disconnected. One connection made with a dirty or damaged connector can damage both connectors beyond repair.

Magnification is helpful when inspecting connectors, but it is not required and may actually be misleading. Defects and damage that cannot be seen without magnification generally have no effect on electrical or mechanical performance. Magnification is of great use in analyzing the nature and cause of damage and in cleaning connectors, but it is not required for inspection.

### Look for Obvious Defects and Damage First

Examine the connectors first for obvious defects and damage: badly worn plating on the connector interface, deformed threads, or bent, broken, or misaligned center conductors. Connector nuts should move smoothly and be free of burrs, loose metal particles, and rough spots.

### What Causes Connector Wear?

Connector wear is caused by connecting and disconnecting the devices. The more use a connector gets, the faster it wears and degrades. The wear is greatly accelerated when connectors are not kept clean, or are not connected properly.

Connector wear eventually degrades performance of the device. Calibration components should have a long life if their use is on the order of a few times per week. Replace components with worn connectors.

The test port connectors on the network analyzer test set may have many connections each day, and are therefore more subject to wear. It is recommended that an adapter be used as a test port saver to minimize the wear on the test set's test port connectors.

### Inspect the Mating Plane Surfaces

Flat contact between the connectors at all points on their mating plane surfaces is required for a good connection. See [Figure 2-1 on page 2-3](#). Look especially for deep scratches or dents, and for dirt and metal particles on the connector mating plane surfaces. Also look for signs of damage due to excessive or uneven wear or misalignment.

Light burnishing of the mating plane surfaces is normal, and is evident as light scratches or shallow circular marks distributed more or less uniformly over the mating plane surface. Other small defects and cosmetic imperfections are also normal. None of these affect electrical or mechanical performance.

If a connector shows deep scratches or dents, particles clinging to the mating plane surfaces, or uneven wear, clean and inspect it again. Devices with damaged connectors should be discarded. Determine the cause of damage before connecting a new, undamaged connector in the same configuration.

## Inspect Female Connectors

Inspect the contact fingers in the female center conductor carefully. These can be bent or broken, and damage to them is not always easy to see. A connector with damaged contact fingers will not make good electrical contact and must be replaced.

---

**NOTE** This is particularly important when mating nonprecision to precision devices.

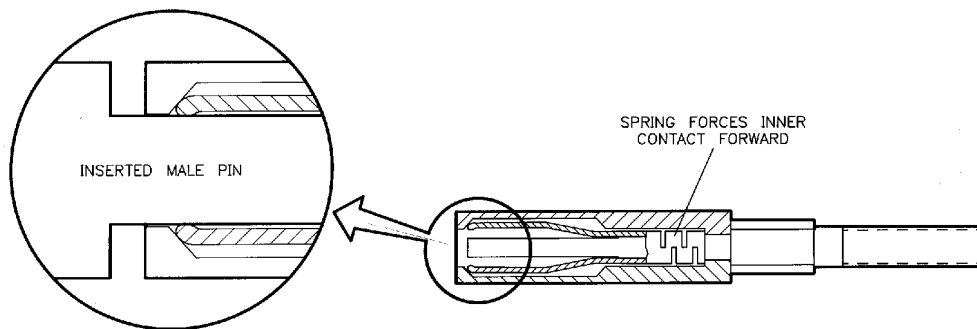
---

The female 3.5 mm connectors in this calibration kit are metrology-grade, precision slotless connectors (PSC). Precision slotless connectors are used to improve accuracy. With PSCs on test ports and standards, the accuracy achieved when measuring at 50 dB return loss levels is comparable to using conventional slotted connectors measuring devices having only 30 dB return loss. This represents an accuracy improvement of about 10 times.

Conventional female center conductors are slotted and, when mated, are flared by the male pin. Because physical dimensions determine connector impedance, this change in physical dimension affects electrical performance, making it very difficult to perform precision measurements with conventional slotted connectors.

The precision slotted connector was developed to eliminate this problem. The PSC has a center conductor with a solid cylindrical shell, the outside diameter of which does not change when mated. Instead, this center conductor has an internal contact that flexes to accept the male pin.

**Figure 3-2 Detail of Precision Slotless Female Connector**



---

## Cleaning Connectors

Clean connectors are essential for ensuring the integrity of RF and microwave coaxial connections.

### 1. Use Compressed Air or Nitrogen



---

**WARNING** Always use protective eyewear when using compressed air or nitrogen.

---

Use compressed air (or nitrogen) to loosen particles on the connector mating plane surfaces. Clean air cannot damage a connector or leave particles or residues behind.

You can use any source of clean, dry, low-pressure compressed air or nitrogen that has an effective oil-vapor filter and liquid condensation trap placed just before the outlet hose.

Ground the hose nozzle to prevent electrostatic discharge, and set the air pressure to less than 414 kPa (60 psi) to control the velocity of the air stream. High-velocity streams of compressed air can cause electrostatic effects when directed into a connector. These electrostatic effects can damage the device. Refer to [“Electrostatic Discharge”](#) earlier in this chapter for additional information.

## 2. Clean the Connector Threads

---

**WARNING** Keep isopropyl alcohol away from heat, sparks, and flame. Store in a tightly closed container. It is extremely flammable. In case of fire, use alcohol foam, dry chemical, or carbon dioxide; water may be ineffective.

**Use isopropyl alcohol with adequate ventilation and avoid contact with eyes, skin, and clothing. It causes skin irritation, may cause eye damage, and is harmful if swallowed or inhaled. It may be harmful if absorbed through the skin. Wash thoroughly after handling.**

**In case of spill, soak up with sand or earth. Flush spill area with water.**

**Dispose of isopropyl alcohol in accordance with all applicable federal, state, and local environmental regulations.**

---

Use a lint-free swab or cleaning cloth moistened with isopropyl alcohol to remove any dirt or stubborn contaminants on a connector that cannot be removed with compressed air or nitrogen. Refer to [Table 6-2 on page 6-4](#) for a part number for cleaning swabs.

- a. Apply a small amount of isopropyl alcohol to a lint-free cleaning swab.
- b. Clean the connector threads.
- c. Let the alcohol evaporate, then blow the threads dry with a gentle stream of clean, low-pressure compressed air or nitrogen. Always completely dry a connector before you reassemble or use it.

## 3. Clean the Mating Plane Surfaces

- a. Apply a small amount of isopropyl alcohol to a lint-free cleaning swab.
- b. Clean the center and outer conductor mating plane surfaces. Refer to [Figure 2-1 on page 2-3](#). When cleaning a female connector, avoid snagging the swab on the center conductor contact fingers by using short strokes.

**Cleaning Connectors**

- c. Let the alcohol evaporate, then blow the connector dry with a gentle stream of clean, low-pressure compressed air or nitrogen. Always completely dry a connector before you reassemble or use it.

**4. Inspect**

Inspect the connector to make sure that no particles or residue remain. Refer to [“Visual Inspection”](#) on page 3.

---

## Gaging Connectors

The gages available from Agilent Technologies are intended for preventive maintenance and troubleshooting purposes only. They are effective in detecting excessive center conductor protrusion or recession, and conductor damage on DUTs, test accessories, and the calibration kit devices. Do not use the gages for precise pin depth measurements. See [Table 6-1 on page 6-2](#) for part number information.

### Connector Gage Accuracy

The connector gages are only capable of performing coarse measurements. They do not provide the degree of accuracy necessary to precisely measure the pin depth of the kit devices. This is partially due to the repeatability uncertainties that are associated with the measurement. Only the factory—through special gaging processes and electrical testing—can accurately verify the mechanical characteristics of the devices.

With proper technique, the gages are useful in detecting gross pin depth errors on device connectors. To achieve maximum accuracy, random errors must be reduced by taking the average of at least three measurements having different gage orientations on the connector. Even the resultant average can be in error by as much as  $\pm 0.0001$  inch due to systematic (biasing) errors usually resulting from worn gages and gage masters. The information in [Table 2-2 on page 2-4](#) assumes new gages and gage masters. Therefore, these systematic errors were not included in the uncertainty analysis. As the gages undergo more use, the systematic errors can become more significant in the accuracy of the measurement.

The measurement uncertainties in are primarily a function of the assembly materials and design, and the unique interaction each device type has with the gage. Therefore, these uncertainties can vary among the different devices. For example, note the difference between the uncertainties of the opens and shorts in [Table 2-2](#).

The observed pin depth limits in [Table 2-2](#) add these uncertainties to the typical factory pin depth values to provide practical limits that can be referenced when using the gages. See [“Pin Depth” on page 3](#). Refer to [“Kit Contents” on page 2](#) for more information on the design of the calibration devices in the kit.

---

**NOTE** When measuring pin depth, the measured value (resultant average of three or more measurements) contains uncertainty and is not necessarily the true value. Always compare the measured value with the observed pin depth limits (which account for measurement uncertainties) in [Table 2-2](#) to evaluate the condition of device connectors.

---

## When to Gage Connectors

Gage a connector at the following times:

- Prior to using a device for the first time: record the pin depth measurement so that it can be compared with future readings. (It will serve as a good troubleshooting tool when you suspect damage may have occurred to the device.)
- If either visual inspection or electrical performance suggests that the connector interface may be out of typical range (due to wear or damage, for example).
- If a calibration device is used by someone else or on another system or piece of equipment.
- Initially after every 100 connections, and after that as often as experience indicates.

## Gaging Procedures

### Gaging Male 3.5 mm Connectors

---

**NOTE** Always hold a connector gage by the gage barrel, below the dial indicator. This gives the best stability, and improves measurement accuracy. (Cradling the gage in your hand or holding it by the dial applies stress to the gage plunger mechanism through the dial indicator housing.)

---

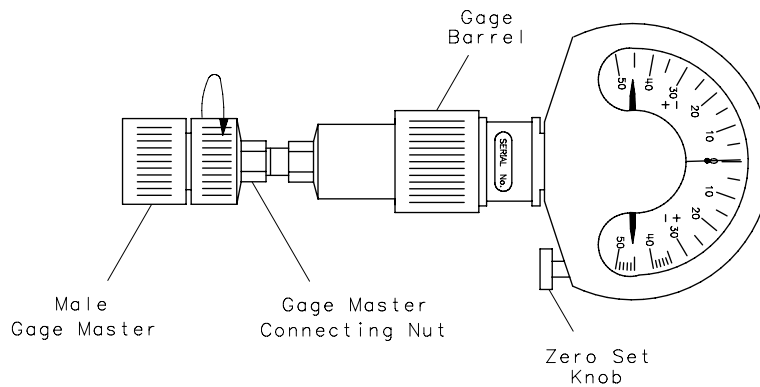
1. Select the proper gage for your connector. Refer to [Table 6-2 on page 6-4](#) for gage part numbers.
2. Inspect and clean the gage, gage master, and device to be gaged. Refer to “Visual Inspection” and “Cleaning Connectors” earlier in this chapter.
3. Zero the connector gage (refer to [Figure 3-3](#)):
  - a. While holding the gage by the barrel, and without turning the gage or the device, screw the male gage master connecting nut onto the male gage, just until you meet resistance. Connect the nut finger tight. Do not overtighten.
  - b. Using an open-end wrench to keep the gage from rotating, use the torque wrench recommended for use with the kit to tighten the connecting nut to the specified torque. Refer to “Final Connection Using a Torque Wrench” on page 13 for additional information.
  - c. As you watch the gage pointer, gently tap the barrel of the gage to settle the reading. The gage pointer should line up exactly with the zero mark on the gage. If not, adjust the zero set knob until the gage pointer lines up exactly with zero.
  - d. Remove the gage master.
4. Gage the device connector (refer to [Figure 3-3](#)):
  - a. While holding the gage by the barrel, and without turning the gage or the device, screw the connecting nut of the male device being measured onto the male gage, just until you meet resistance. Connect the nut finger-tight. Do not overtighten.
  - b. Using an open-end wrench to keep the gage from rotating, use the torque wrench recommended for use with the kit to tighten the connecting nut to the specified torque. Refer to “Final Connection Using a Torque Wrench” on page 13 for additional information.
  - c. Gently tap the barrel of the gage with your finger to settle the gage reading.
  - d. Read the gage indicator dial. Read *only* the black  $\pm$  signs; *not* the red  $\pm$  signs.

For maximum accuracy, measure the connector a minimum of three times and take an average of the readings. After each measurement, rotate the gage a quarter-turn to reduce measurement variations that result from the gage or the connector face not being exactly perpendicular to the center axis.
  - e. Compare the average reading with the observed pin depth limits in [Table 2-2 on page 2-4](#).

**Figure 3-3 Gaging Male 3.5 mm Connectors**

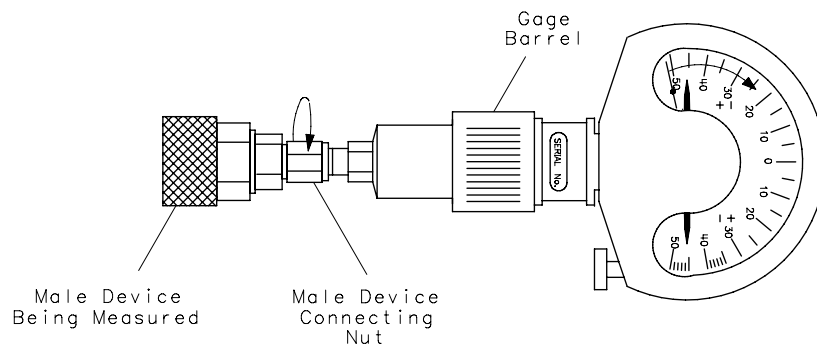
Zero the Connector Gage

- Screw the male gage master connecting nut onto the male gage.
- Torque the connecting nut.
- Gently tap the gage barrel to settle the reading.
- Using the zero set knob, adjust the gage pointer to line up exactly with the zero mark.
- Remove the gage master.



Gage the Device Connector

- Screw the male device connecting nut onto the male gage.
- Torque the connecting nut.
- Gently tap the gage barrel to settle the reading.
- Read recession or protrusion from the gage.
- Remove the device.
- Repeat two additional times and average the three readings.



pk55c

## Gaging Female 3.5 mm Connectors

---

**NOTE** Always hold a connector gage by the gage barrel, below the dial indicator. This gives the best stability, and improves measurement accuracy. (Cradling the gage in your hand or holding it by the dial applies stress to the gage plunger mechanism through the dial indicator housing.)

---

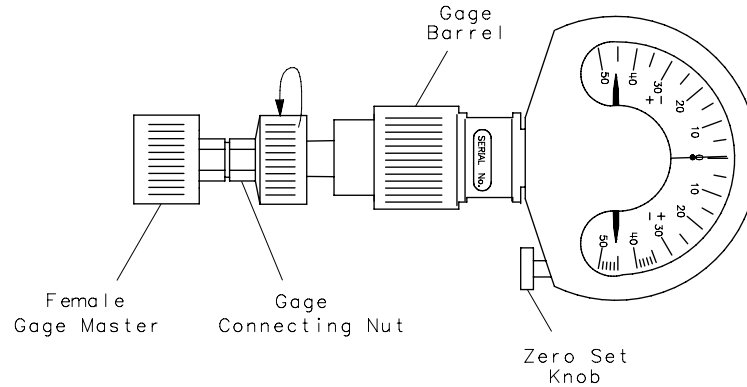
1. Select the proper gage for your connector. Refer to [Table 6-2 on page 6-4](#) for gage part numbers.
2. Inspect and clean the gage, gage master, and device to be gaged. Refer to “Visual Inspection” and “Cleaning Connectors” earlier in this chapter.
3. Zero the connector gage (refer to [Figure 3-4](#)):
  - a. While holding the gage by the barrel, and without turning the gage or the device, screw the female gage connecting nut onto the female gage master, just until you meet resistance. Connect the nut finger-tight. Do not overtighten.
  - b. Using an open-end wrench to keep the gage master from rotating, use the torque wrench recommended for use with the kit to tighten the connecting nut to the specified torque. Refer to “Final Connection Using a Torque Wrench” on page 13 for additional information.
  - c. As you watch the gage pointer, gently tap the barrel of the gage to settle the reading. The gage pointer should line up exactly with the zero mark on the gage. If not, adjust the zero set knob until the gage pointer lines up exactly with zero.
  - d. Remove the gage master.
4. Gage the device connector (refer to [Figure 3-4](#)):
  - a. While holding the gage by the barrel, and without turning the gage or the device, screw the female gage connecting nut onto the female device being measured, just until you meet resistance. Connect the nut finger-tight. Do not overtighten.
  - b. Using an open-end wrench to keep the gage master from rotating, use the torque wrench recommended for use with the kit to tighten the connecting nut to the specified torque. Refer to “Final Connection Using a Torque Wrench” on page 13 for additional information.
  - c. Gently tap the barrel of the gage with your finger to settle the gage reading.
  - d. Read the gage indicator dial. Read *only* the black  $\pm$  signs; *not* the red  $\pm$  signs.

For maximum accuracy, measure the connector a minimum of three times and take an average of the readings. Use different orientations of the gage within the connector. After each measurement, rotate the gage a quarter-turn to reduce measurement variations that result from the gage or the connector face not being exactly perpendicular to the center axis.
  - e. Compare the average reading with the observed pin depth limits in [Table 2-2 on page 2-4](#).

**Figure 3-4 Gaging Female 3.5 mm Connectors**

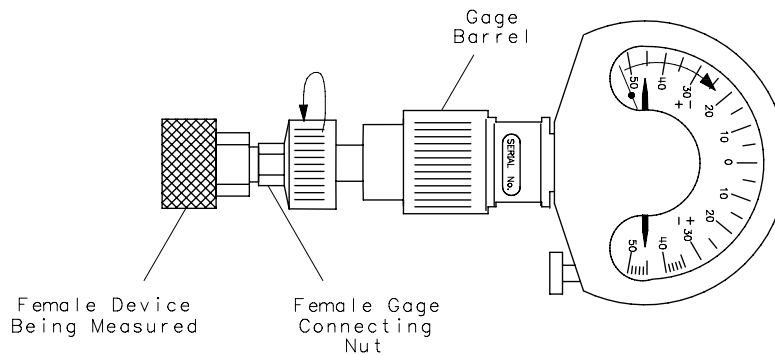
Zero the Connector Gage

- Screw the female gage connecting nut onto the female gage master.
- Torque the connecting nut.
- Gently tap the gage barrel to settle the reading.
- Using the zero set knob, adjust the gage pointer to line up exactly with the zero mark.
- Remove the gage master.



Gage the Device Connector

- Screw the female gage connecting nut onto the female device.
- Torque the connecting nut.
- Gently tap the gage barrel to settle the reading.
- Read recession or protrusion from the gage.
- Remove the device.
- Repeat two additional times and average the three readings.



pk56c



## Connections

Good connections require a skilled operator. *The most common cause of measurement error is bad connections.* The following procedures illustrate how to make good connections.

### How to Make a Connection

#### Preliminary Connection

1. Ground yourself and all devices. Wear a grounded wrist strap and work on a grounded, conductive table mat. Refer to [“Electrostatic Discharge” on page 2](#) for ESD precautions.
2. Visually inspect the connectors. Refer to [“Visual Inspection” on page 3](#).
3. If necessary, clean the connectors. Refer to [“Cleaning Connectors” on page 4](#).
4. Use a connector gage to verify that all center conductors are within the observed pin depth values in [Table 2-2 on page 2-4](#). Refer to [“Gaging Connectors” on page 7](#).
5. Carefully align the connectors. The male connector center pin must slip concentrically into the contact finger of the female connector.
6. Push the connectors straight together and tighten the connector nut finger tight.

---

**CAUTION** Do not turn the device body. Only turn the connector nut. Damage to the center conductor can occur if the device body is twisted.

---

Do not twist or screw the connectors together. As the center conductors mate, there is usually a slight resistance.

7. The preliminary connection is tight enough when the mating plane surfaces make uniform, light contact. Do not overtighten this connection.

A connection in which the outer conductors make gentle contact at all points on both mating surfaces is sufficient. Very light finger pressure is enough to accomplish this.

8. Make sure the connectors are properly supported. Relieve any side pressure on the connection from long or heavy devices or cables.

### Final Connection Using a Torque Wrench

Use a torque wrench to make a final connection. [Table 3-1](#) provides information about the torque wrench recommended for use with the calibration kit. A torque wrench is included in the calibration kit. Refer to [Table 6-2 on page 6-4](#) for replacement part number and ordering information.

**Table 3-1 Torque Wrench Information**

Connector Type	Torque Setting	Torque Tolerance
3.5 mm	90 N-cm (8 in-lb)	±9.0 N-cm (±0.8 in-lb)

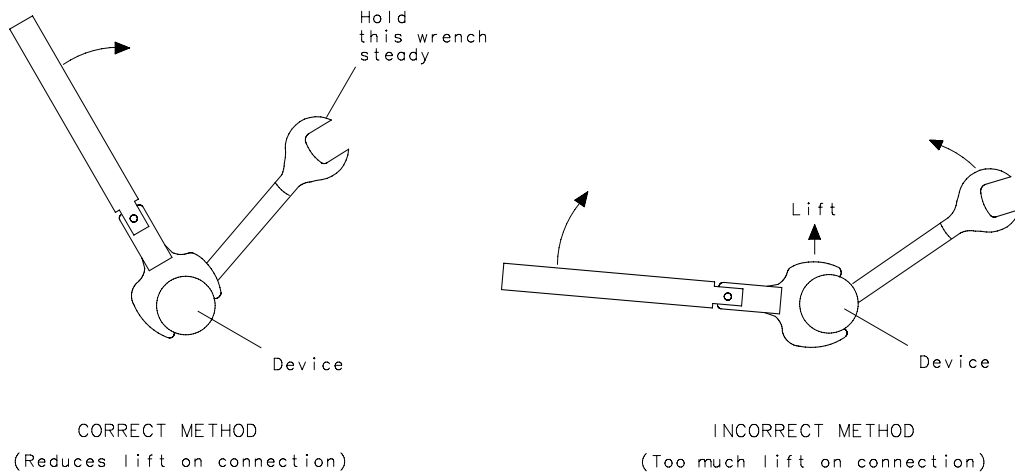
Using a torque wrench guarantees that the connection is not too tight, preventing possible

connector damage. It also guarantees that all connections are equally tight each time.

Prevent the rotation of anything other than the connector nut that you are tightening. It may be possible to do this by hand if one of the connectors is fixed (as on a test port). However, it is recommended that you use an open-end wrench to keep the body of the device from turning.

1. Position both wrenches within 90 degrees of each other before applying force. See [Figure 3-5](#). Wrenches opposing each other (greater than 90 degrees apart) will cause a lifting action which can misalign and stress the connections of the devices involved. This is especially true when several devices are connected together.

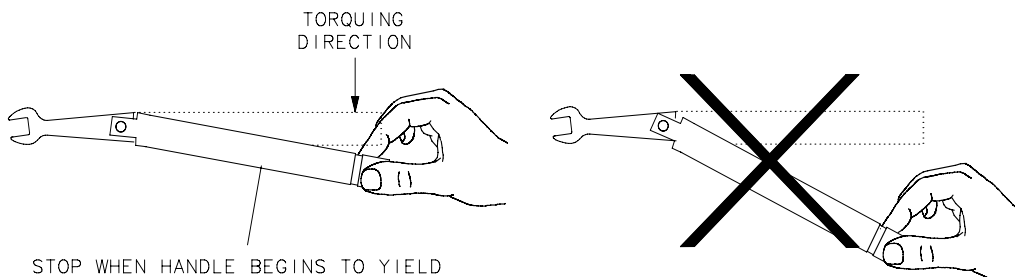
**Figure 3-5 Wrench Positions**



wj56f

2. Hold the torque wrench lightly, at the end of the handle only (beyond the groove). See [Figure 3-6](#).

**Figure 3-6 Using the Torque Wrench**



wj68d

3. Apply downward force perpendicular to the wrench handle. This applies torque to the connection through the wrench.

Do not hold the wrench so tightly that you push the handle straight down along its length rather than pivoting it, otherwise you apply an unknown amount of torque.

4. Tighten the connection just to the torque wrench break point. The wrench handle gives way at its internal pivot point. See [Figure 3-6](#). Do not tighten the connection further.

---

**CAUTION** You don't have to fully break the handle of the torque wrench to reach the specified torque; doing so can cause the handle to kick back and loosen the connection. Any give at all in the handle is sufficient torque.

---

## How to Separate a Connection

To avoid lateral (bending) force on the connector mating plane surfaces, always support the devices and connections.

---

**CAUTION** Do *not* turn the device body. Only turn the connector nut. Damage to the center conductor can occur if the device body is twisted.

---

1. Use an open-end wrench to prevent the device body from turning.
2. Use another open-end wrench to loosen the connector nut.
3. Complete the separation by hand, turning only the connector nut.
4. Pull the connectors straight apart without twisting, rocking, or bending either of the connectors.

---

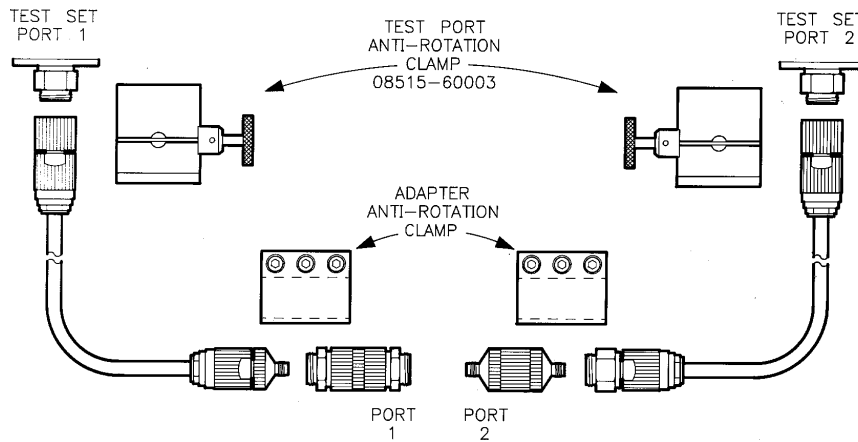
## Handling and Storage

- Install the protective end caps and store the calibration devices in the foam-lined storage case when not in use.
- Never store connectors loose in a box, or in a desk or bench drawer. This is the most common cause of connector damage during storage.
- Keep connectors clean.
- Do not touch mating plane surfaces. Natural skin oils and microscopic particles of dirt are easily transferred to a connector interface and are very difficult to remove.
- Do not set connectors contact-end down on a hard surface. The plating and the mating plane surfaces can be damaged if the interface comes in contact with any hard surface.

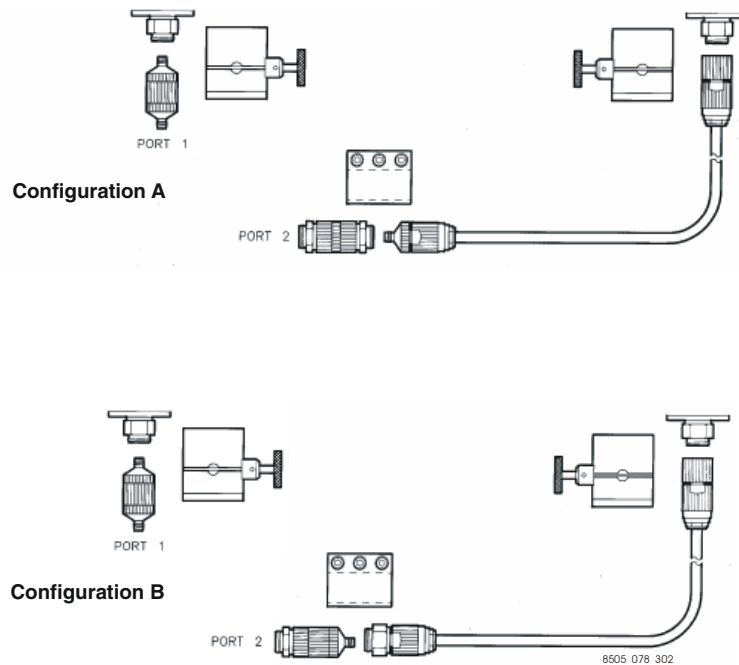
## Configuring Port 1 and Port 2 of the Test Setup

Several configurations of the test setup are possible, depending upon the frequency range, available cables, operator convenience, and DUT requirements. Following is an example setup using the two-cable set, and two examples using a single cable. The appropriate precision adapters are installed on the ends of the cables and become Port 1 and Port 2.

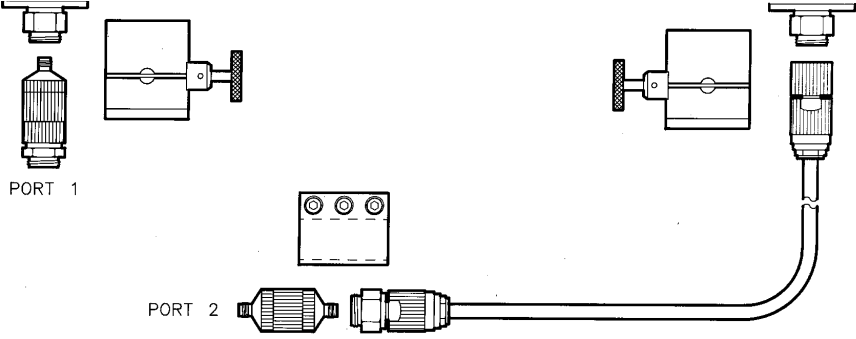
**Figure 3-7 Dual Cable Set**



**Figure 3-8 Single Cable, Port 1 Female**



**Figure 3-9. Single Cable, Port 1 Male**



## Installing Test Port Return Cables and Test Port Anti-Rotation Clamps

When all parts are ready for use, connect the test port extension cables and test port anti-rotation clamps (not included - see [Table 6-2 on page 6-4](#) for part number information). To connect a cable to the test set:

- Loosen the test port anti-rotation clamp securing screw and slide the clamp over the cable far enough to provide access to the cable connector.
- Connect the cable to the test port and tighten using the torque wrench.
- Slide the clamp toward the port, aligning it so that the flats on the clamp mate with flats around the test port. Tighten the clamp securing screw. This clamp keeps the cable from becoming loose from the test set connector.

---

## Installing Precision Adapters and Adapter Anti-Rotation Clamps

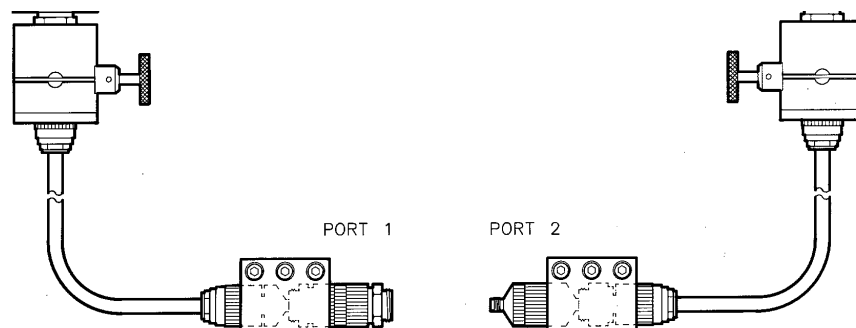
To install the precision adapters and adapter anti-rotation clamps:

- Connect the adapter to the cable, tighten finger tight, and then use the spanner and the torque wrench to achieve the final torque.
- Loosen the adapter anti-rotation clamp securing screws and slide the clamp over the adapter. Align the clamp so that it can grip both the cable connector body and the adapter body. Tighten the clamp securing screws. The screw tightening order is not important.

The adapter anti-rotation clamp assures that the TRL adapter does not become loose during calibration and measurement.

- Connect the second TRL adapter and its anti-rotation clamp to serve as Port 2.

**Figure 3-10 Two Cable Setup with All Components**



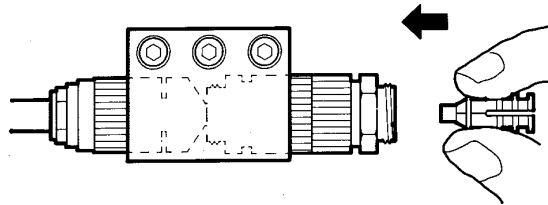
## Using Precision Airlines

### When Stop Frequency Is Greater than 7 GHz

If the stop frequency is greater than 7 GHz, install the 7-32 GHz air line as follows:

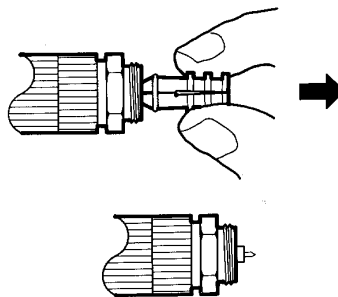
- Move the Port 1 nut to its standard position and carefully insert the air line into the male connector using the installation tool.

**Figure 3-11 Insert Air Line**



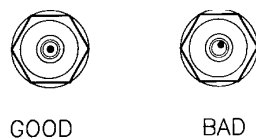
- Squeeze the installation tool (closing the slot) to release the center conductor. Then pull the tool away from the connector, leaving the outer and the center conductors in place.

**Figure 3-12 Squeeze Tool to Release, Then Pull**



- Examine the outer and center conductors to see that they are in place and concentric. If the center conductor is not centered, use the installation tool to align it.

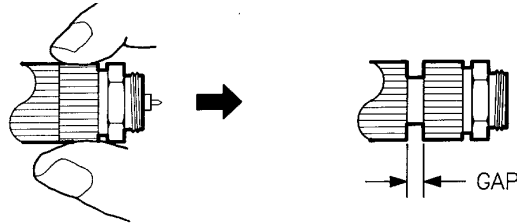
**Figure 3-13 Check Concentricity**





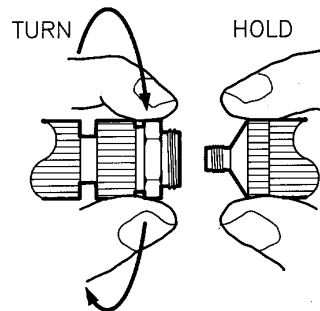
- Move the adapter nut to its extended position. For more information, refer to “Precision Adapters” on page 5.

**Figure 3-14 Extended Position with Air Lines Installed**



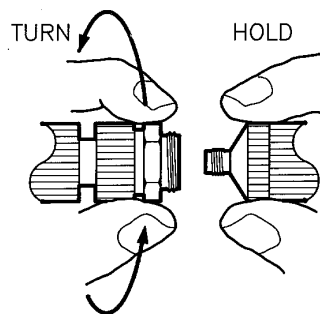
- Carefully align and engage the Port 2 female contact with the Port 1 male contact.
- Tighten finger tight, then use the spanner and torque wrenches to achieve the final torque.

**Figure 3-15 Connect Port 2**



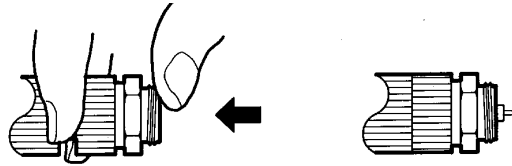
- To remove the 7-32 GHz air line: loosen the Port 1 nut, and then carefully move the Port 2 adapter away.

**Figure 3-16 Disconnect Port 2**



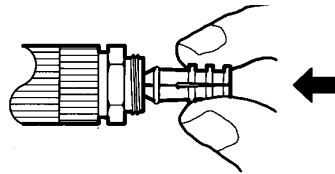
- Move the adapter nut to its standard position.

**Figure 3-17 Standard Position with Air Line Installed**



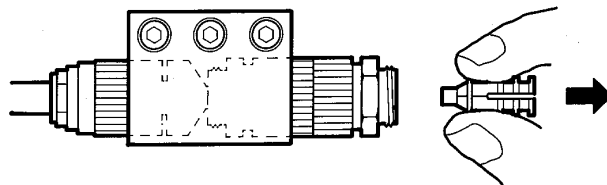
- Examine the outer and center conductors to see that they are in place.
- Carefully press the insertion tool onto the connector.

**Figure 3-18. Connect the Insertion Tool**



- Hold the tool close to the connector without squeezing the tool. Carefully pull the assembly away from the connector.

**Figure 3-19 Remove the 7-32 Line**



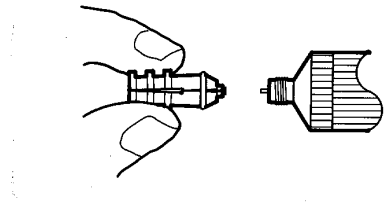
- Check to see that both the inner and the outer conductor have been removed and are secure in the installation tool.

If any part of the air line remains attached to the male port, first press the tool back onto the connector. Then, try to withdraw the tool and the air line parts again without closing the slot.

If the air line center conductor remains with the female port, use the installation tool to remove it as follows:

- Squeeze the tool and push it to engage the center conductor.
- Hold the tool close to the connector, squeeze the tool without closing the slot, and pull the assembly away.
- Use your fingers to remove the center conductor from the tool.

**Figure 3-20 Remove Center Conductor from Port 2 (if necessary)**



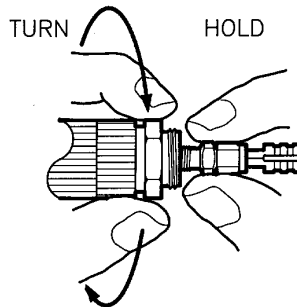
- Carefully insert the center conductor back into the installation tool, male end first.

### **When Start Frequency Is Less Than 7 GHz**

If the start frequency is less than 7 GHz, install the 2-7 GHz air line as follows:

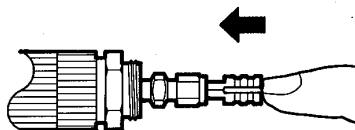
- Move the Port 1 nut to its standard position. Carefully insert the air line outer conductor and center pin into the male connector using the installation tool.
- Hold the air line outer conductor and tighten the Port 1 nut finger tight. Use the torque wrench to achieve the final torque.

**Figure 3-21 Connect the 2-7 Line**



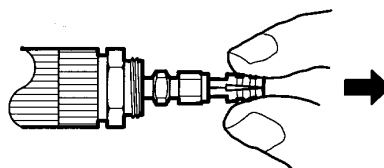
- Press the tool lightly to engage the center conductor.

**Figure 3-22 Engage the Center Conductor**



- Squeeze the tool to close the slot, then pull the tool away from the connector, leaving the center conductor.

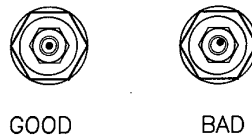
**Figure 3-23 Remove the Tool**



- Examine the outer and center conductors to see that they are in place and concentric. If

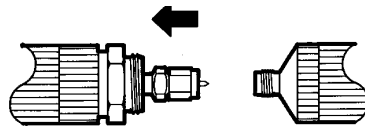
the center conductor is not centered, use the tip of the installation tool to align it.

**Figure 3-24 Check the Concentricity**



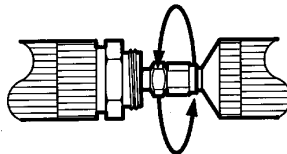
- Move the air line nut back to expose the center conductor. Carefully engage the Port 2 female contact with the Port 1 male contact. Be patient when making this connection because it is easy to move the center conductor off center.

**Figure 3-25 Move the Nut Back**



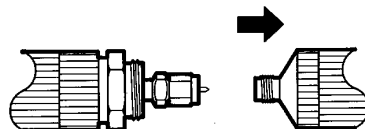
- Move the nut forward to engage the threads, tighten finger tight, then use the spanner and the torque wrench to achieve the final torque.

**Figure 3-26 Connect Port 2**



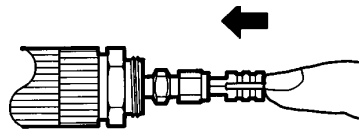
- To remove the 2-7 GHz air line: loosen the air line nut and carefully move Port 2 away from Port 1.

**Figure 3-27 Disconnect Port 2**



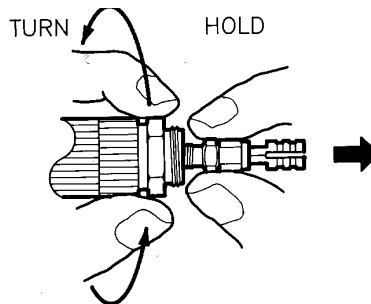
- Insert the tool and lightly press it to engage the center conductor.

**Figure 3-28 Engage the Tool**



- Loosen the adapter nut and then disconnect the outer conductor from the adapter. The center conductor will be removed with the outer conductor.

**Figure 3-29 Remove 2-7 Line**

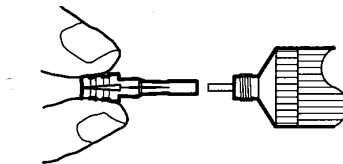


---

**NOTE** It is important to be very careful to move Port 2 away in a straight motion because the center conductor may stay Port 2. If the center conductor remains with the female port, use the installation tool to remove it. Carefully insert the center conductor back into the insertion tool, male end first.

---

**Figure 3-30 Remove Center Conductor from Port 2 (if necessary)**



## Performing a TRL 2-Port Calibration for a Coaxial Device Measurement

TRL represents a family of calibration techniques that measure various combinations of transmission lines and reflection standards to determine the 2-Port 12-term error coefficients. The specific calibration technique described here uses measurements of the zero-length thru connection, identical reflection standards at each port, and one or more transmission lines of appropriate impedance and length for the frequency range. Both the TRL 2-PORT and the Full 2-Port calibration types use the same accuracy enhancement mathematics to correct the measured data. TRL, as implemented with this calibration kit, brings convenience, accuracy, and repeatability to the error correction process because the typical TRL calibration requires fewer parts that are simpler to connect and disconnect.

The procedure used for performing the TRL calibration is as follows:

1. Clean and inspect all connectors.
2. Initiate measurement calibration procedure and measure standards.
3. Verify the calibration.
4. Connect the device under test.

---

**NOTE** For information on TRL calibration for non-coaxial device measurements, refer to Agilent Product Note 8510-8A, “Applying the 8510 TRL Calibration for Non-Coaxial Measurements.” Although the title specifies the 8510, this document contains a lot of good generic information about TRL calibration that is applicable to any vector network analyzer. To download a free copy, go to [www.agilent.com](http://www.agilent.com) and enter literature number 8510-8A in the Search box.

---

### PNA-Series Network Analyzers

Rather than document here the details of the PNA procedure for performing a TRL calibration, Agilent recommends that customers use the PNA SmartCal (Guided Calibration). This PNA feature provides a step-by-step “wizard” interface to walk you through the calibration. Steps are explained using both text and graphics. For more information on SmartCal, refer to your PNA’s embedded Help system. To view PNA Help online, go to [www.agilent.com](http://www.agilent.com) and type PNA Help in the Search box.

## NOTE

Using adapter clamps, precision adapters, and air lines require too many instructions to all be included as prompts on the analyzer display during a TRL calibration procedure. For complete instructions on using these devices, please refer to the following sections in this manual:

- “Precision Adapters” on page 1-5
  - “Precision Airlines” on page 1-6
  - “Installing Precision Adapters and Adapter Anti-Rotation Clamps” on page 3-19
  - “Using Precision Airlines” on page 3-20
- 

## 872x-Series and 875x-Series Network Analyzers

Although the 872x and 875x network analyzers don't have the SmartCal feature like the PNA, they do provide step-by-step prompts for performing a TRL calibration. For more information on the most complicated TRL calibration steps, refer to the Note above and to your analyzer's User's Guide. To view your analyzer's User's Guide online, go to [www.agilent.com](http://www.agilent.com) and type your analyzer model number (ex: 8719ES) in the Search box. Click on the hyperlink for Manuals.

## 8510-Series Network Analyzers

This example describes use of the 8510-series network analyzer and the 85052C 3.5 mm Precision Calibration Kit to perform a TRL 2-port calibration for measuring an insertable device. When the test device is insertable, the test ports can be connected together to establish the Thru connection during calibration.

### Load Calibration Kit Definition

You can load the calibration kit definition into 8510 memory from a floppy disk or manually using the analyzer's front panel keys. For instructions, refer to the analyzer's User's Guide online - go to [www.agilent.com](http://www.agilent.com)

Copies of the disk are no longer offered by Agilent, but you can make your own copy containing the downloaded file from Agilent's Calibration Kit Definitions Web page at [www.na.tm.agilent.com/pna/caldefs/stddefs.html](http://www.na.tm.agilent.com/pna/caldefs/stddefs.html). If you don't have a floppy disk drive to make a copy, you must manually enter the values from the Web page.

When the calibration kit definition is loaded, the CAL 1 softkey label will read 3.5 mm C. 1.

### Measure Standards

---

**NOTE** The standards are measured in the order: Thru, Reflect, Line, Isolation in order to connect the load standards just once.

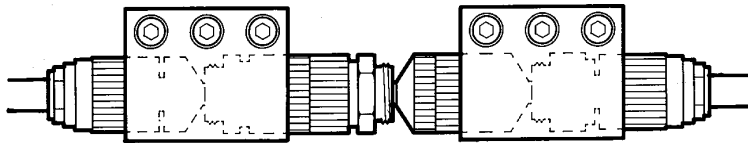
---

Press:

**CAL**  
**CAL 1**  
**TRL 2-PORT**

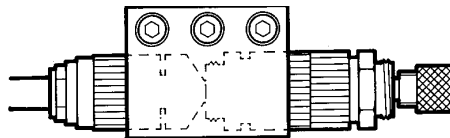
- Connect the TRL male adapter (Port 1) to the TRL female adapter (Port 2).
- Press **THRU**. The 8510 makes six measurements; they are  $S_{11}$ ,  $S_{21}$ ,  $S_{12}$ ,  $S_{22}$ , and two specially redefined user parameters.

**Figure 3-31 Thru Standards**



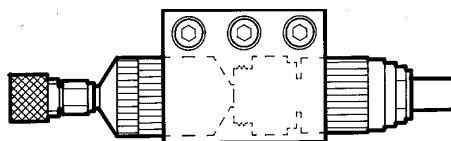
- Connect the Short circuit to Port 1.
- Press  **$S_{11}$  REFLECT SHORT**.  $S_{11}$  is measured.

**Figure 3-32  $S_{11}$  Reflection Short Standard**



- Connect the Short circuit to Port 2.
- Press  **$S_{22}$  REFLECT SHORT**.  $S_{22}$  is measured.
- Press **LINES**.

**Figure 3-33  $S_{22}$  Reflection Short Standard**



Refer to “When Stop Frequency Is Greater than 7 GHz” on page 20 or “When Start Frequency Is Less Than 7 GHz” on page 23 as necessary.

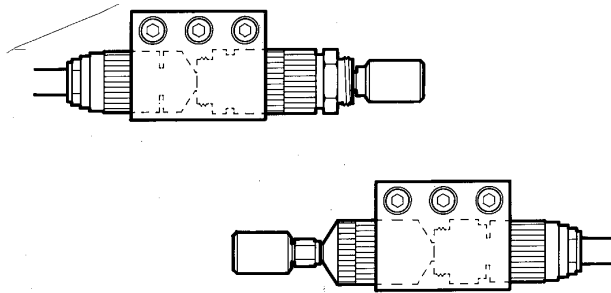
**When Start Frequency Is Less than 2 GHz** If the start frequency is less than 2 GHz, measure the 0-2 Loads as follows:

- Connect a fixed load to Port 1 and a fixed load to Port 2.
- Press **0-2 LOADS**. The 8510 makes six measurements. All frequencies are measured, but only data up to 2 GHz are used. These measurements replace error coefficients obtained from measurement of the 2-7 GHz air line below 2 GHz. Leave the loads connected for



the Isolation step.

**Figure 3-34 Connect the 0-2 Loads**



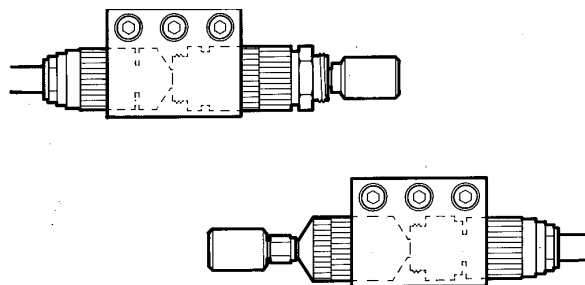
- Press **LINES DONE**.
- Press **ISOLATION**.

If maximum transmission dynamic range is not required, skip the isolation part of the calibration by pressing **OMIT ISOLATION** and then **ISOLATION DONE**.

Or, to obtain maximum transmission dynamic range, perform the isolation part of the calibration as follows:

- Connect a fixed load to Port 1 and a fixed load to Port 2.
- Increase the **AVERAGING FACTOR** for the isolation measurement to at least 128. Then press **FWD. ISOL'N ISOL'N STD**.  $S_{21}$  is measured.
- Press **REV. ISOL'N ISOL'N STD**.  $S_{12}$  is measured.
- Press **ISOLATION DONE**. You may wish to reduce the averaging factor for measurement of the device under test.
- Press **SAVE TRL 2-PORT**.

**Figure 3-35 Reverse Isolation Standards**



When the computation of error coefficients is complete, press **CAL SET 1** (or any other cal set). Error coefficients derived from measurement of the TRL standards are computed and saved, and then 2-Port correction is turned on.

---

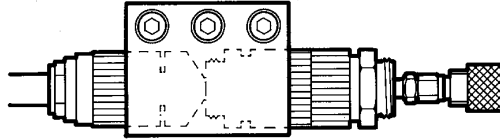
**CAUTION** Carefully inspect the connectors on the device under test (DUT) and measure their center conductor pin depth before connecting the DUT to the system. DUT connectors with incorrect pin size, pin depth, or pin alignment can



Select:

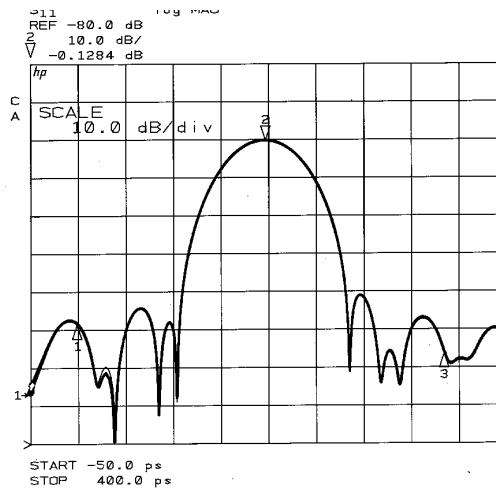
**S<sub>11</sub>**  
**DOMAIN**  
**TIME BAND PASS**

**Figure 3-38 Line with Short Circuit**



View the  $S_{11}$  response. Use the marker to measure the responses at 0 seconds (a rough measure of effective directivity) and the mismatch at twice the length of the air line (a rough measure of effective source match). The trace should appear as shown below. If not, the calibration has not been performed correctly or the calibration components are defective.

**Figure 3-39 Plot of Time Band with Shorted Air Line**



## Adapter Removal Calibration

---

**NOTE** Adapter Removal calibration is a very accurate calibration method for measuring non-insertable devices with the 872x-series and 875x-series vector network analyzers. However, it is NOT the most accurate calibration method for the PNA. For information on PNA calibration methods for measuring non-insertable devices, refer to your PNA's embedded Help system. To view PNA Help online, go to [www.agilent.com](http://www.agilent.com) and type PNA Help in the Search box.

---

### General Theory

The following sequence describes the adapter removal method of calibration for measurement of a noninsertable device. This procedure is the most complete and effective calibration procedure for measurement of noninsertable devices with the 872x-series and 875x-series vector network analyzers. Although this technique does require two separate 2-Port calibrations, it remains the only traceable method for minimizing the uncertainty in this measurement. The three precision adapters in this calibration kit provide the parts required to make the process relatively easy.

Detailed information about the adapter removal calibration is contained in Product Note 8510-13. To download a free copy, go to [www.agilent.com](http://www.agilent.com) and enter literature number 8510-13 in the Search box.

The previous calibration sequence assumed that the device under test is insertable; it has a male connector on one port and a female connector on the other port. Thus, the measurement system can be calibrated and then the test device inserted without changing the system test port connectors.

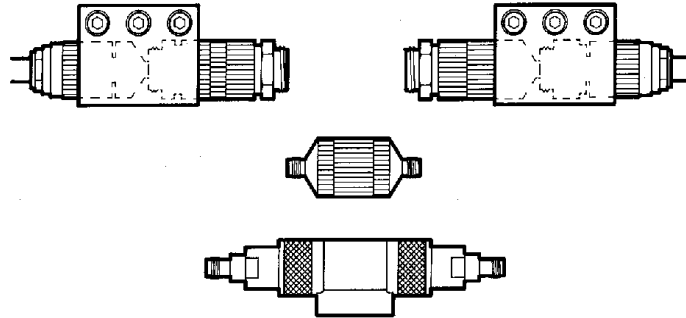
However, the majority of devices used in microwave systems are noninsertable. Of interest here are devices having either both male or both female 3.5 mm connectors on Port 1 and Port 2.

### Noninsertable Device Configurations

#### Female to Female

If the device you are measuring has two female connectors, your setup would look like the figure below. The female-to-female precision adapter is substituted for the DUT to accomplish this calibration.

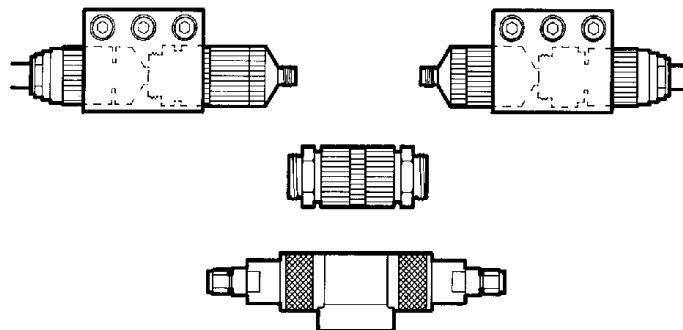
**Figure 3-40 Female-Female Device Under Test**



**Male to Male**

If the DUT you are measuring has two male connectors, your setup would look like the figure below. The male-to-male precision adapter is substituted for the DUT to accomplish this calibration.

**Figure 3-41 Male-Male Device Under Test**



**Adapter Removal Calibration Procedure**

**Create Cal Set for Port 1**

First create the Port 1 calibration set by performing the TRL 2-Port calibration between Port 1 and the adapter. Keep the adapter connected to Port 2 during the entire procedure. Save the calibration in Cal Set 1.

**Figure 3-42 Port 1 Cal Set**



**Create Cal Set for Port 2**

Next create the Port 2 calibration set by performing the TRL 2-Port calibration between Port 2 and the adapter. Keep the adapter connected to Port 1 during the entire procedure. Save the calibration in Cal Set 2.

**Figure 3-43 Port 2 Cal Set**



### Adapter Removal Mathematics

---

**NOTE** In the following procedure, the keystrokes are specific to 8510-series network analyzers. For 872x or 875x keypresses, refer to the analyzer's User's Guide. To view your analyzer's User's Guide online, go to [www.agilent.com](http://www.agilent.com) and type your analyzer model number (ex: 8719ES) in the Search box. Click on the hyperlink for Manuals and Guides.

---

The Adapter Removal function mathematically combines the Port 1 cal set with the Port 2 cal set to produce a third cal set having the effects of the adapter removed. The resulting cal set is as if Port 1 and Port 2 could be connected together.

When the two calibrations have been saved, proceed with the adapter removal sequence as follows:

Press:

**CAL  
MORE  
MODIFY CAL SET  
ADAPTER REMOVAL**

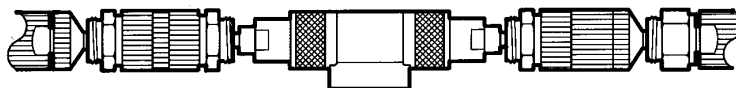
- Press **CAL SET for PORT 1**, then **CAL SET 1**.
- Press **CAL SET for PORT 2**, then **CAL SET 2**.
- Press **ADAPTER 3.5 mm C.1**. This specifies the calibration kit that includes the length specification for the precision adapter.
- Press **MODIFY & SAVE**, then **CAL SET 3**.

The new calibration set is computed and stored. 2-Port correction is turned on.

Now remove the third adapter and connect the DUT.

The display should now show an accurate S-parameter measurement of the DUT.

**Figure 3-44 Remove the Adapter and Connect the DUT**



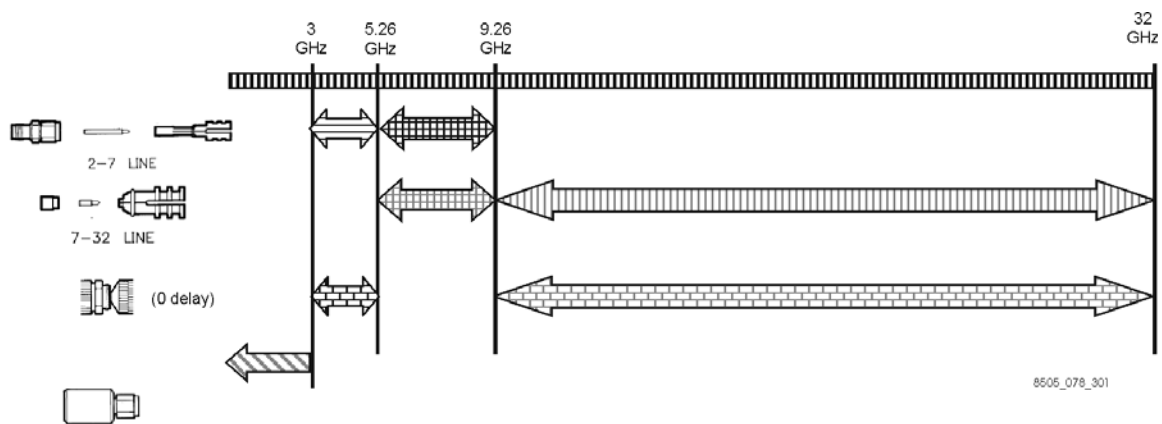
## Offset Load Calibration

Offset load calibration uses the precision offset transmission lines to remove the reflection of the load. The transmission line's impedance now becomes the calibrated reference impedance, similar to the TRL calibration. Although the Agilent 8510 had provisions for offset load calibration, the 85052C calibration kit definitions were never set up for the offset load standards because one must use the special test port adapters in an unusual way to provide the offsets. Since many users want to be able to use the precision kit to perform precision 1-port calibrations, the offset load standards are defined for the PNA. This also enables the precision SOLT calibration. The PNA offset load calibration is more accurate than the 8510 implementation. It accounts for both transmission loss and delay of the offset transmission lines. The solution also includes the impact of port match reflection tracking errors in a weighted least squares formulation. Phase margin requirements of offset load calibration are different from TRL calibration. See the following table and illustrations.

**Table 3-2 Offset Load Calibration**

Fixed load	<3 GHz
0 delay load - and - 2 to 7 GHz line with load	<=5.26 GHz
2 to 7 GHz line with load - and - 7 to 32 GHz line with load	<9.26 GHz
0 delay load - and - 7 to 32 GHz line with load	<=32 GHz

**Figure 3-45 Offset Load Calibration: Frequency Range of Calibration Devices**

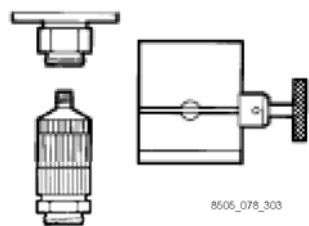


## Offset Load Calibration Sequence for the PNA

### Procedure A: Female Test Port on DUT

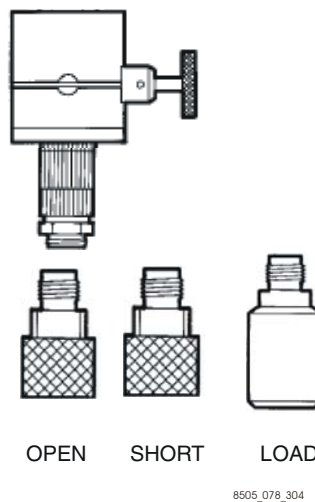
1. Using an anti-rotation clamp, connect and secure the –m– to –f– precision TRL adapter to the analyzer test port. In the remainder of Procedure A, this adapter will be referred to as the “retractable test port connector.”

**Figure 3-46 Procedure A, Step 1 Illustration**



2. Select **Guided Cal.**
3. Measure the open.
4. Measure the short.
5. Measure the load.

**Figure 3-47 Procedure A, Steps 3–5**

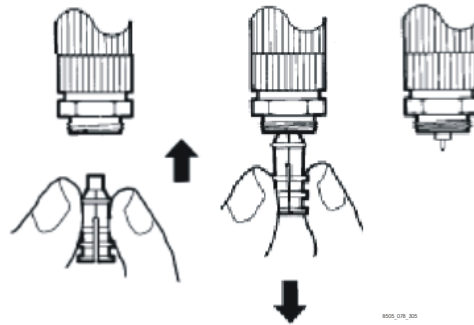


Before performing the following steps, see the section [“Using Precision Airlines” on page 3-20](#) for detailed instructions on how to connect and disconnect precision airlines to/from test port connectors.

6. Connect the 7-32 GHz offset airline to the retractable test port connector.

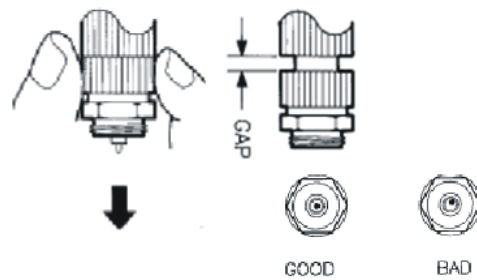


**Figure 3-48 Procedure A, Step 6 Illustration**



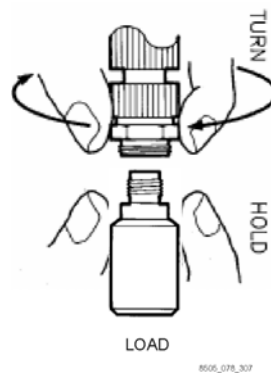
7. Check to make sure the center conductor and outer conductor are concentric.
8. Pull the outer ring of the retractable test port connector to extend the outer nut.

**Figure 3-49 Procedure A, Steps 7 and 8 Illustration**



9. Carefully connect the load to the retractable test port connector. Make sure the load is aligned and goes in straight.

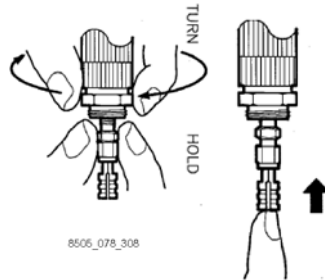
**Figure 3-50 Procedure A, Step 9 Illustration**



10. Measure the load, then disconnect it.
11. Disconnect the 7-32 GHz offset airline.

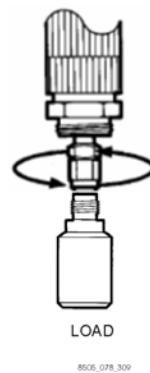
12. Push the extended outer nut back on the retractable test port connector.
13. Connect the 2-7 GHz offset airline to the retractable test port connector.

**Figure 3-51 Procedure A, Steps 12 and 13 Illustration**



14. Check to make sure the center conductor and outer conductor are concentric. Refer to [Figure 3-49 on page 3-37](#).
15. Carefully connect the load to the retractable test port connector. Make sure the load is aligned and goes in straight.

**Figure 3-52 Procedure A, Step 15 Illustration**

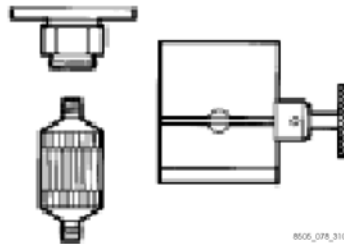


16. Measure the load.
17. Disconnect the 2-7 GHz offset airline.

### Procedure B: Male Test Port on DUT

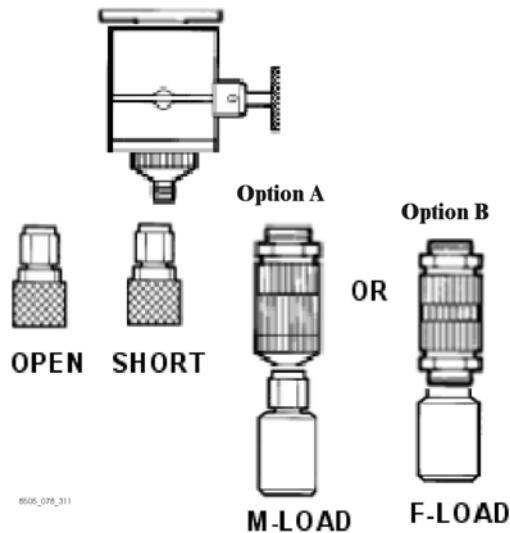
1. Using an anti-rotation clamp, connect and secure the  $-f-$  to  $-f-$  precision TRL adapter to the analyzer test port. In the remainder of Procedure B, this adapter will be referred to as the “test port connector.”

**Figure 3-53 Procedure B, Step 1 Illustration**



2. Select **Guided Cal.**
3. Measure the open.
4. Measure the short.
5. Make *one* of the following combinations:
  - Connect a  $-m-$  load to the  $-m-$  to  $-f-$  precision TRL adapter (Option A), *or*
  - Connect a  $-f-$  load to the  $-m-$  to  $-m-$  precision TRL adapter (Option B)
6. Connect either combination as the load to the test port connector.
7. Measure the load.

**Figure 3-54 Procedure B, Steps 3–7 Illustration**

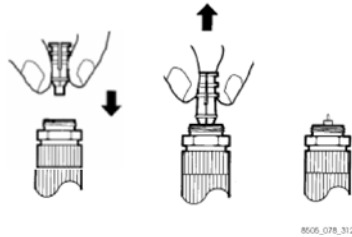


Before performing the following steps, see the section [“Using Precision Airlines”](#) on [page 3-20](#) for detailed instructions on how to connect and disconnect precision airlines

to/from test port connectors.

8. Connect the 7-32 GHz offset airline to the retractable connector of the adapter.

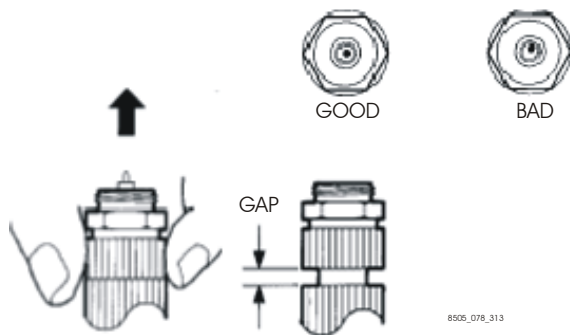
**Figure 3-55 Procedure B, Step 8 Illustration**



9. Check to make sure the center conductor and outer conductor are concentric.

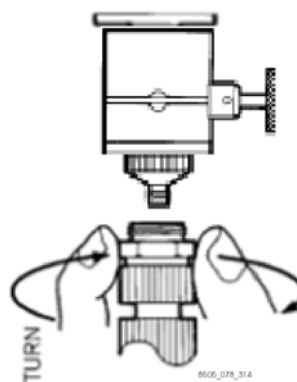
10. Pull the outer ring of the adapter to extend the outer nut.

**Figure 3-56 Procedure B, Steps 9 and 10 Illustration**



11. Carefully connect the airline/retractable connector of the adapter to the test port connector. Make sure the center contacts mate properly.

**Figure 3-57 Procedure B, Step 11 Illustration**

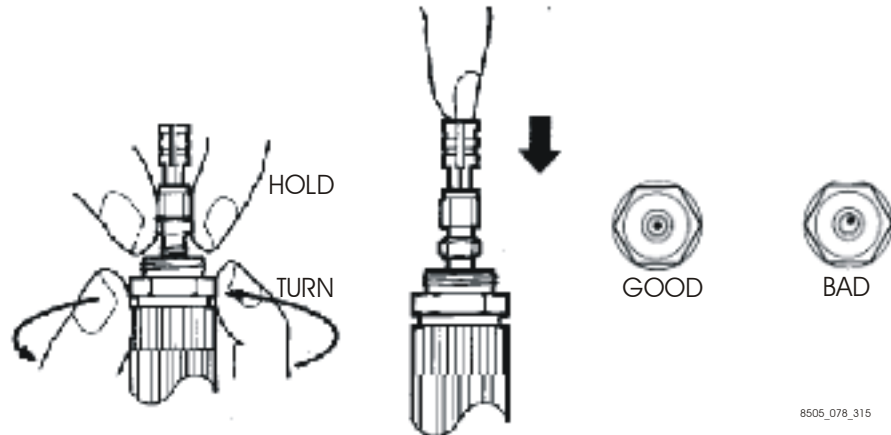


12. Measure the load.

13. Disconnect the adapter from the test port connector.

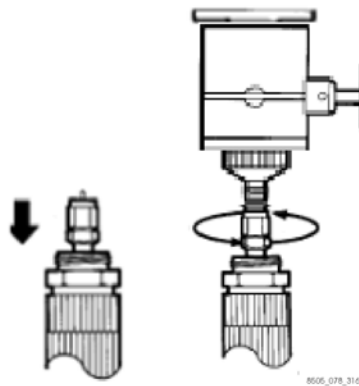
14. Disconnect the 7-32 GHz offset airline from the retractable connector of the adapter.
15. Push the extended outer nut of the adapter back.
16. Connect the 2-7 GHz offset airline to the retractable connector of the adapter.
17. Check to make sure the center conductor and outer conductor are concentric.

**Figure 3-58 Procedure B, Steps 15–17 Illustration**



18. Carefully connect the airline/retractable connector of the adapter to the test port connector. Make sure the center contacts mate properly.

**Figure 3-59 Procedure B, Step 18 Illustration**



19. Measure the load.
20. Disconnect the adapter from the test port connector.
21. Disconnect the 2-7 GHz offset airline from the retractable connector of the adapter.

To perform an Open/Short/Load/Offset Load calibration, perform a 1-port calibration. If the setup is like [Figure 3-8 Configuration A](#), use Option A of the female port, 1-port calibration. If the setup is like [Figure 3-8 Configuration B](#), use Option B of the female port, 1-port calibration.



---

## **4 Performance Verification**

## Introduction

The performance of your calibration kit can only be verified by returning the kit to Agilent Technologies for recertification. The equipment required to verify the specifications of the devices in the kit has been specially manufactured and is not commercially available.

---

## How Agilent Verifies the Devices in Your Kit

Agilent verifies the specifications of these devices as follows:

1. The residual microwave error terms of the test system are verified with precision airlines and shorts that are directly traced to the National Institute of Standards and Technology (NIST). The airline and short characteristics are developed from mechanical measurements. The mechanical measurements and material properties are carefully modeled to give very accurate electrical representation. The mechanical measurements are then traced to NIST through various plug and ring gages and other mechanical measurements.
2. Each calibration device is electrically tested on this system. For the initial (before sale) testing of the calibration devices, Agilent includes the test measurement uncertainty as a guardband to guarantee each device meets the published specification. For recertifications (after sale), no guardband is used and the measured data is compared directly with the specification to determine the pass or fail status. The measurement uncertainty for each device is, however, recorded in the calibration report that accompanies recertified kits.

These two steps establish a traceable link to NIST for Agilent to the extent allowed by the institute's calibration facility. The specifications data provided for the devices in the kit is traceable to NIST through Agilent Technologies.



---

## Recertification

The following will be provided with a recertified kit:

- a new calibration sticker affixed to the case
- a certificate of calibration
- a calibration report for each device in the kit listing measured values, specifications, and uncertainties

---

**NOTE** A list of NIST traceable numbers may be purchased upon request to be included in the calibration report.

---

Agilent Technologies offers a *Standard* calibration for the recertification of the kit. For more information, contact the nearest Agilent Technologies sales or service office. See [“Contacting Agilent” on page 5-5](#).

## How Often to Recertify

The suggested initial interval for recertification is 12 months or sooner. The actual need for recertification depends on the use of the kit. After reviewing the results of the initial recertification, you may establish a different recertification interval that reflects the usage and wear of the kit.

---

**NOTE** The recertification interval should begin on the date the kit is *first used* after the recertification date.

---

## Where to Send a Kit for Recertification

Contact Agilent Technologies for information on where to send your kit for recertification. See [“Contacting Agilent” on page 5-5](#). Refer to [“Returning a Kit or Device to Agilent” on page 5-4](#) for details on sending your kit.



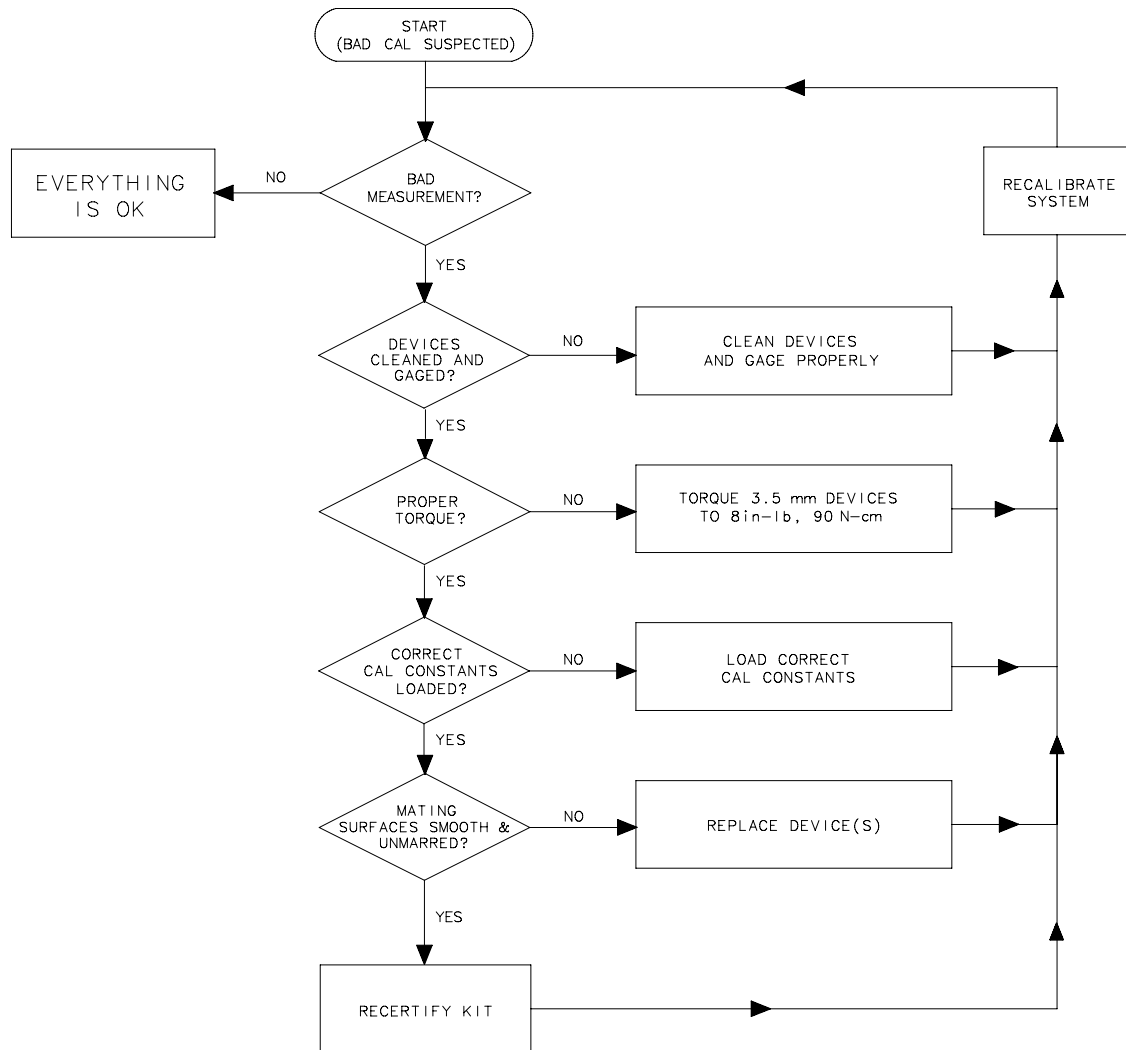
---

## **5 Troubleshooting**

## Troubleshooting Process

If you suspect a bad calibration, or if your network analyzer does not pass performance verification, follow the steps in [Figure 5-1](#).

**Figure 5-1 Troubleshooting Flowchart**



pk54c

## Where to Look for More Information

This manual contains limited information about network analyzer system operation. For detailed information on using a VNA, ENA or PNA series network analyzer, refer to the appropriate user guide or online Help.

- To view the ENA or PNA online Help, press the Help key on the front panel of the network analyzer.
- To view an online VNA user guide, use the following steps:
  1. Go to *www.agilent.com*.
  2. Enter your VNA model number (Ex: 8753ES) in the Search box and click **Search**.
  3. Under the heading **Manuals & Guides**, click on the title/hyperlink for the document PDF you want to view.

If you need additional information, see [Contacting Agilent on page 5-5](#).

## Returning a Kit or Device to Agilent

If your kit or device requires service, contact Agilent Technologies for information on where to send it. See [Contacting Agilent on page 5-5](#) for information. Include a service tag (located near the end of this manual) on which you provide the following information:

- your company name and address
- a technical contact person within your company, and the person's complete phone number
- the model number and serial number of the kit
- the part number and serial number of each device
- the type of service required
- a *detailed* description of the problem and how the device was being used when the problem occurred (such as calibration or measurement)

---

## Contacting Agilent

Assistance with test and measurements needs and information on finding a local Agilent office are available on the Web at:

*[www.agilent.com/find/assist](http://www.agilent.com/find/assist)*

If you do not have access to the Internet, please contact your Agilent field engineer.

---

**NOTE**      In any correspondence or telephone conversation, refer to the Agilent product by its model number and full serial number. With this information, the Agilent representative can determine whether your product is still within its warranty period.

---





---

## **6 Replaceable Parts**

## Introduction

Table 6-1 lists the replacement part numbers for items included in the 85052C calibration kit and Figure 6-1 illustrates each of these items.

Table 6-2 lists the replacement part numbers for items *not* included in the calibration kit that are either required or recommended for successful operation of the kit.

To order a listed part, note the description, the part number, and the quantity desired. Telephone or send your order to Agilent Technologies. See [Contacting Agilent on page 5-5](#) for information.

**Table 6-1 Replaceable Parts for the 85052C Calibration Kit**

Description <sup>a</sup>	Qty Per Kit	Agilent Part Number
<b>Calibration Devices (3.5 mm)</b>		
–m– broadband load	1	00902-60003
–f– broadband load	1	00902-60004
–m– offset open	1	85052-60008
–f– offset open	1	85052-60009
–m– offset short	1	85052-60006
–f– offset short	1	85052-60007
<b>Precision Adapters (3.5 mm)</b>		
–m– to –m–	1	85052-60033
–f– to –f–	1	85052-60032
–m– to –f–	1	85052-60034
<b>Precision Airlines</b>		
Long, 2 to 7 GHz (includes insertion tool)	1	85052-60036
Short, 7 to 32 GHz (includes insertion tool)	1	85052-60035
<b>Protective End Caps for Connectors</b>		
Protective Cap 0.234 ID	as required	1401-0202
Protective Cap 0.313 ID	as required	1401-0208
Protective Cap 0.812 ID	as required	1401-0214

**Table 6-1 Replaceable Parts for the 85052C Calibration Kit**

Description <sup>a</sup>	Qty Per Kit	Agilent Part Number
<b>Tools</b>		
5/16 in, 90 N-cm (8 in-lb) torque wrench	1	8710-1765
Spanner wrench	1	08513-20014
4-mm hex balldriver	1	8710-1933
Adapter anti-rotation clamp	2	85052-20060
<b>Calibration Kit Storage Case</b>		
Box (without foam pads)	1	5180-8419
Foam pad (for lid)	1	5180-7807
Foam pad (for lower case)	1	85052-80037
Foam pad (in between lid and lower case)	1	5181-5522
<b>Miscellaneous Items</b>		
85052C User's and Service Guide <sup>b</sup>	1	85052-90078

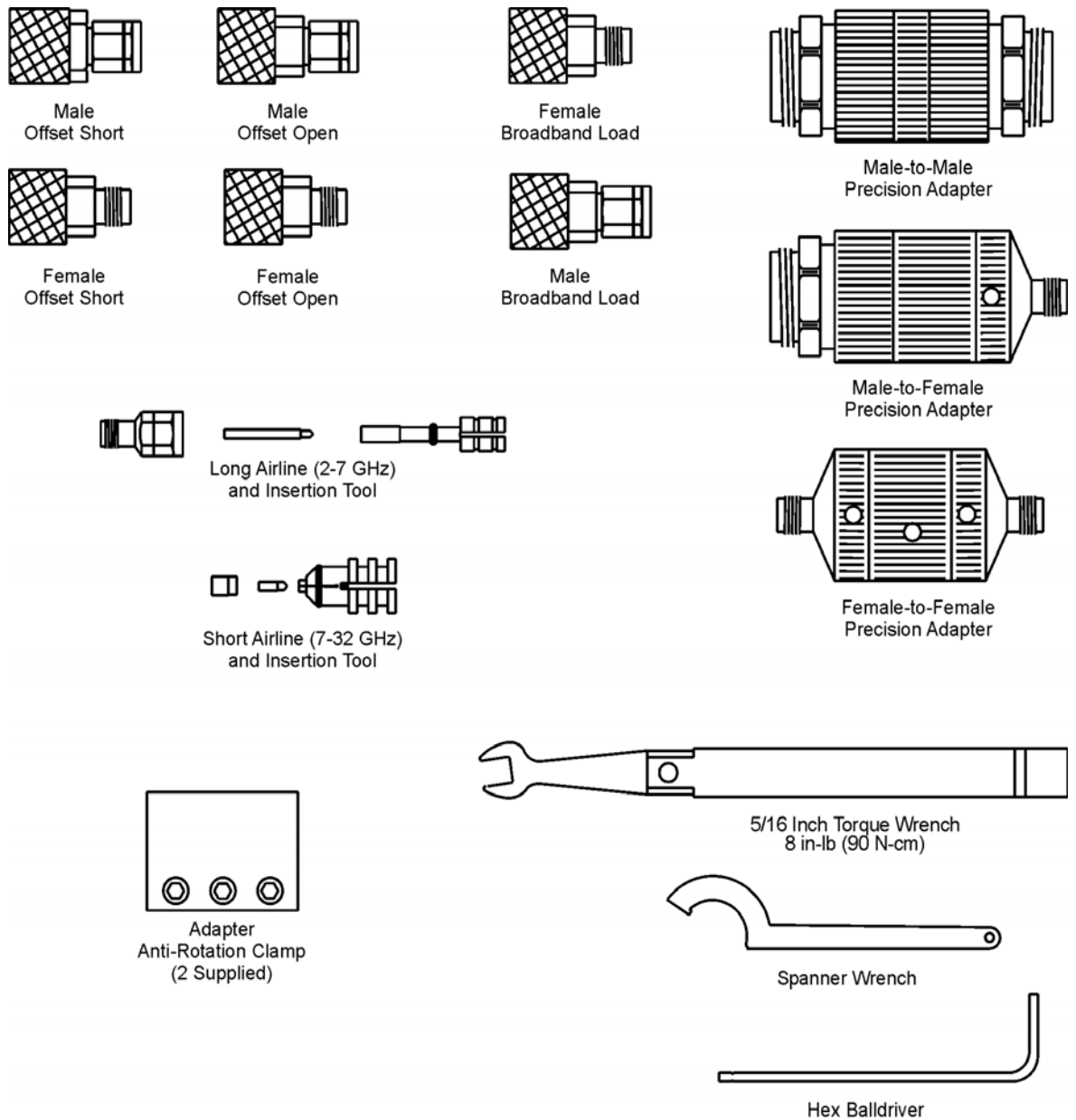
- a. Refer to [Clarifying the Terminology of a Connector Interface on page 1-15](#).
- b. See ["Printing Copies of Documentation from the Web" on page ii](#).

**Table 6-2 Items Not Included in the Calibration Kit**

Description	Qty	Agilent Part Number
<b>Connector Gages (3.5 mm)</b>		
Gage Set (for female connectors)	1	85052-60043
Gage Set (for male connectors)	1	85052-60042
<b>Tools</b>		
7 mm open-end wrench	1	8710-1761
20 mm, 0.9 N-m (8 in-lb) torque wrench	1	8710-1764
Test port anti-rotation clamp	2	08515-60003
<b>Slotless Connector Repair Kit</b>		
3.5 mm slotless connector contact repair kit <sup>a</sup>	1	85052-60049
<b>ESD Protection Devices</b>		
Grounding wrist strap	1	9300-1367
Heel strap		9300-1308
5 ft grounding cord for wrist strap	1	9300-0980
2 ft by 4 ft conductive table mat with 15 ft grounding wire	1	9300-0797
<b>Connector Cleaning Supplies</b>		
Anhydrous isopropyl alcohol (>92% pure) <sup>b</sup>	--	--
Cleaning swabs	100	9301-1243

- a. All female connectors on the precision devices in this kit are slotless connectors. Refer to [“Inspect Female Connectors” on page 3-4](#).
- b. Agilent can no longer safely ship isopropyl alcohol, so customers should purchase it locally.

**Figure 6-1 Component Identification Sheet for the 85052C Calibration Kit**



**NOT SHOWN:**

- User's and Service Guide
- Storage case
- Protective end caps

pk57c



---

# **A Standard Definitions**

## **Class Assignments and Standard Definitions Values are Available on the Web**

Class assignments and standard definitions may change as more accurate model and calibration methods are developed. You can download the class assignments and standard definitions from Agilent's Calibration Kit Definitions Web page at <http://na.tm.agilent.com/pna/caldefs/stddefs.html>.

For a detailed discussion of calibration kits, refer to the Agilent Application Note, "Specifying Calibration Standards and Kits for Agilent Vector Network Analyzers." This application note covers calibration standard definitions, calibration kit content and its structure requirements for Agilent vector network analyzers. It also provides some examples of how to set up a new calibration kit and how to modify an existing calibration kit definition file. To download a free copy, go to [www.agilent.com](http://www.agilent.com) and enter literature number 5989-4840EN in the Search window.



## Numerics

8510 network analyzer, [1-11](#)

## A

adapter anti-rotation clamp  
part number, [6-3](#)

adapter removal calibration, 8510  
analyzer, [3-32](#)

adapters, [1-5](#)  
extended position, [1-6](#), [3-21](#)  
part numbers, [6-2](#)  
precision connectors, [1-5](#)  
recession limits, [1-5](#)  
standard position, [1-6](#), [3-22](#)

Agilent Technologies  
application note, [A-2](#)  
contacting, [5-5](#)

agreements  
customer assistance, [-iii](#)  
maintenance, [-iii](#)

airlines  
installation tools, [1-7](#), [3-22](#),  
[3-23](#), [3-25](#)  
part numbers, [6-2](#)  
precision  
2 to 7 GHz, [1-6](#), [3-23](#)  
7 to 32 GHz, [1-6](#), [3-20](#)  
frequency coverage, [1-8](#)

alcohol  
isopropyl  
as cleaning solvent, [3-5](#)  
precautions for use of, [3-5](#)

altitude  
specifications, [2-2](#)

anti-rotation clamps  
adapter, [3-19](#)  
test port, [3-18](#)

assistance  
customer, [-iii](#)  
who to contact, [-iii](#)

## B

balldriver  
hex  
part number, [6-3](#)

box  
pads  
part numbers, [6-3](#)

broadband loads, [1-3](#)  
part numbers, [6-2](#)  
specifications, [2-5](#)

## C

cal kit  
performance  
verifying, [4-2](#)

calibration  
adapter removal, 8510 analyzer,  
[3-32](#)  
bad, [5-2](#)  
certificate of, [4-3](#)  
checking, [3-30](#)  
constants, *See* calibration  
definitions  
frequency, [1-16](#)  
MIL-STD 45662, [4-3](#)  
offset load, [3-35](#)  
report, [4-3](#)  
temperature, [2-2](#)  
TRL  
8510, [3-27](#)  
PNA, 872x, and 875x, [3-26](#)  
when to perform, [1-16](#)

calibration definitions, [1-11](#)  
entering, [1-11](#)

calibration kit  
Agilent Application Note, [A-2](#)  
contents, [1-2](#), [6-5](#)  
drawing of, [6-5](#)  
modifying definition files, [A-2](#)  
overview, [1-2](#)  
performance  
how Agilent verifies, [4-2](#)  
verifying, [4-2](#)

case  
storage  
part number, [6-3](#)

certificate of calibration, [4-3](#)

certification  
of device specifications, [2-6](#)

characteristics  
mechanical, [2-3](#)

checking the calibration, [3-30](#)

clamp  
adapter anti-rotation  
installing, [3-19](#)  
part number, [6-3](#)  
test port anti-rotation  
installing, [3-18](#)

class assignments  
downloading from Agilent Web  
site, [A-2](#)

cleaning connectors, [3-4](#)

cleaning supplies, [1-11](#)  
part number, [6-4](#)

cleaning swabs, [3-5](#)  
part number, [6-4](#)

compressed air  
for cleaning, [3-4](#)

conductive mat  
part number, [6-4](#)

configuration  
noninsertable device, [3-32](#)

one or two cables, [3-16](#)

connections, [3-2](#), [3-13](#)  
ESD protection, [3-13](#)  
final, [3-13](#)  
preliminary, [3-13](#)  
separating, [3-15](#)  
using torque wrench, [3-13](#)

connector  
3.5 mm, [1-10](#)  
cleaning, [3-4](#)  
damage, [3-3](#)  
defects, [3-3](#)  
female, [3-4](#), [3-11](#)  
gage  
accuracy, [3-7](#)  
handling, [3-7](#)  
use of, [3-7](#)  
zeroing, [3-7](#)  
gaging, [3-7](#)  
to determine pin depth, [3-7](#)  
when to do, [3-8](#)  
gender, [1-15](#)  
male, [3-9](#)  
mating plane surfaces, [3-5](#)  
cleaning, [3-5](#)  
slotless, [1-14](#), [3-4](#), [6-4](#)  
slotless repair kit  
part number, [6-4](#)  
terminology, [1-15](#)  
threads  
cleaning, [3-5](#)  
inspecting, [3-3](#)  
visual inspection, [3-3](#)  
wear, [3-3](#)  
affect on electrical  
performance, [3-3](#)

connector gage  
accuracy, [3-11](#)  
handling, [3-9](#), [3-11](#)  
use of, [3-11](#)  
zeroing, [3-9](#), [3-11](#)

constants, calibration, *See*  
calibration definitions

contacting Agilent, [5-5](#)

contents  
calibration kit, [6-5](#)  
drawing of, [6-5](#)  
incomplete  
what to do, [1-12](#)

## D

damage  
caused by electrostatic  
discharge, [3-2](#)  
device, [3-3](#)  
inspecting for, [3-3](#)  
to connectors, [3-3](#)

what to do, [1-12](#)  
damaged connectors, [3-3](#)  
data  
  recertification, [4-3](#)  
defective connectors, [3-3](#)  
defects  
  connector, [3-3](#)  
definitions  
  calibration, [1-11](#)  
  entering, [1-11](#)  
  permanently stored, [1-11](#)  
deviation from nominal phase, [2-5](#)  
device  
  connecting, [3-13](#)  
  damage, [3-3](#)  
  disconnecting, [3-15](#)  
  handling, [3-15](#)  
  maintenance, [1-15](#)  
  performance  
  verifying, [4-2](#)  
  specifications, [2-5](#)  
  certification of, [2-6](#)  
  traceability, [4-2](#), [4-3](#)  
  storage, [3-15](#)  
  temperature, [2-2](#)  
  visual inspection, [3-3](#)  
disconnections, [3-15](#)  
documentation  
  part number, [6-3](#)  
downloading class assignments &  
  std definitions from the Web,  
  [A-2](#)  
**E**  
electrical specifications, [2-5](#)  
electrostatic discharge, *See* ESD  
end caps  
  part numbers, [6-2](#)  
environmental  
  regulations, [3-5](#)  
  requirements, [2-2](#)  
  specifications, [2-2](#)  
equipment required, [1-11](#)  
ESD, [3-2](#)  
  precautions, [3-5](#)  
  protection, [3-2](#)  
  supplies, [3-2](#)  
  part numbers, [6-4](#)  
extended position, adapters, [1-6](#),  
  [3-21](#)  
**F**  
female connectors, [3-4](#)  
  inspection of, [3-4](#)  
frequency  
  specifications, [2-5](#)  
frequency of calibration, [1-16](#)

**G**  
gage  
  connector, [1-11](#)  
  handling, [3-9](#), [3-11](#)  
  part numbers, [6-4](#)  
  zeroing, [3-9](#), [3-11](#)  
gaging  
  connectors, [3-7](#)  
  when to do, [3-8](#)  
  female connectors, [3-11](#)  
  male connectors, [3-9](#)  
  to determine pin depth, [3-7](#)  
gender, connector, [1-15](#)  
**H**  
handling, [3-15](#)  
heel strap  
  part number, [6-4](#)  
hex balldriver  
  part number, [6-3](#)  
hookup  
  one or two cables, [3-16](#)  
how often to calibrate, [1-16](#)  
humidity  
  specifications, [2-2](#)  
**I**  
incoming inspection, [1-12](#)  
information, troubleshooting, [5-3](#)  
inspection  
  damage, [3-3](#)  
  defects, [3-3](#)  
  female connectors, [3-4](#)  
  incoming, [1-12](#)  
  mating plane surfaces, [3-3](#)  
  visual, [3-3](#)  
isopropyl alcohol  
  as cleaning solvent, [3-5](#)  
  precautions for use of, [3-5](#)  
**K**  
kit  
  contents, [1-2](#), [6-5](#)  
  drawing of, [6-5](#)  
  overview, [1-2](#)  
**L**  
limits  
  pin depth, [2-4](#)  
loads  
  broadband, [1-3](#)  
  part numbers, [6-2](#)  
**M**  
maintenance, [3-2](#)

agreements, -iii  
of devices, [1-15](#)  
preventive, [1-15](#)  
making connections, [3-13](#)  
  ESD protection, [3-13](#)  
  precautions, [3-13](#)  
manual  
  printing, -ii  
mat  
  conductive  
  part number, [6-4](#)  
mating plane surfaces  
  cleaning, [3-5](#)  
  connector, [3-5](#)  
  inspection of, [3-3](#)  
  mechanical characteristics, [2-3](#)  
  affect on electrical performance,  
  [2-3](#)  
  verifying, [3-7](#)  
MIL-STD 45662  
  calibration, [4-3](#)  
modifying calibration kit  
  definition files, [A-2](#)  
**N**  
National Institute of Standards  
  and Technology (NIST), [2-6](#),  
  [4-2](#)  
network analyzer, 8510, [1-11](#)  
nitrogen  
  for cleaning, [3-4](#)  
noninsertable device  
  configuration, [3-32](#)  
numbers  
  replaceable parts, [6-2](#)  
  serial, [1-13](#)  
  recording, [1-13](#)  
**O**  
observed limits  
  pin depth, [2-4](#)  
offset load calibration, [3-35](#)  
  sequence  
  Procedure A, [3-36](#)  
  Procedure B, [3-39](#)  
offset opens  
  part numbers, [6-2](#)  
offset shorts  
  part numbers, [6-2](#)  
offsets, [1-4](#)  
open-end wrench, [1-11](#), [3-15](#)  
  part number, [6-4](#)  
opens, [1-4](#)  
  part numbers, [6-2](#)  
  specifications, [2-5](#)  
operating and service package  
  part number, [6-3](#)

- ordering
    - parts, 6-2
  - P**
  - part numbers, 6-2
    - of items in kit, 6-2
    - of items not in kit, 6-4
  - parts
    - included in kit, 6-2
    - not included in kit, 6-2, 6-4
    - ordering, 6-2
    - replaceable, 6-2
  - performance verification
    - fail, 5-2
  - pin depth, 2-3
    - affect on electrical performance, 2-4
    - gaging to determine, 3-7
    - observed limits, 2-4, 3-7
    - protrusion, 2-3
    - recession, 2-3
    - typical values, 2-4
  - precision adapters
    - part numbers, 6-2
  - precision airlines
    - 2 to 7 GHz, 1-6, 3-23
    - 7 to 32 GHz, 1-6, 3-20
    - frequency coverage, 1-8
    - installation tools, 1-7, 3-22, 3-23, 3-25
    - part numbers, 6-2
  - precision slotless connectors, 1-14
  - preventive maintenance, 1-15
  - protective end caps
    - part numbers, 6-2
  - protrusion
    - pin depth, 2-3
  - R**
  - recertification
    - how to order, 4-3
    - interval, 4-3
    - what's included, 4-3
    - where it's done, 4-3
  - recession
    - pin depth, 2-3
  - recession limits of adapters, 1-5
  - regulations
    - environmental, 3-5
  - repair kit
    - slotless connector
      - part number, 6-4
  - replaceable parts, 6-2, 6-5
    - drawing of, 6-5
  - report, calibration, 4-3
  - requirements
    - environmental, 2-2
  - return
    - kit or device to Agilent, 5-4
  - return loss
    - specifications, 2-5
  - S**
  - separating connections, 3-15
  - serial numbers, 1-13
    - devices, 1-13
    - recording, 1-13
  - service, 5-4
  - service tag, 1-12, 4-3, 5-4
  - shorts, 1-4
    - part numbers, 6-2
    - specifications, 2-5
  - slotless connector
    - repair kit
      - part number, 6-4
  - spanner wrench
    - part number, 6-3
    - specifications, 2-2
  - altitude
    - operating, 2-2
    - storage, 2-2
  - certification of, 2-6
  - deviation from nominal phase, 2-5
  - device, 2-5
  - electrical, 2-5
  - environmental, 2-2
  - frequency, 2-5
  - humidity
    - operating, 2-2
    - storage, 2-2
  - return loss, 2-5
  - temperature, 2-2
  - torque wrench, 3-13
  - traceability, 4-2, 4-3
- standard definitions
  - downloading from Agilent Web site, A-2
- standard position, adapters, 1-6, 3-22
- standards
  - international, 2-6
  - National Institute of Standards and Technology (NIST), 2-6, 4-2
- static
  - discharge, 3-2
  - electricity, 3-2
  - storage, 3-15
  - storage case
    - part number, 6-3
- strap
  - heel
    - part number, 6-4
- wrist
  - part number, 6-4
- supplies
  - cleaning, 1-11
    - part number, 6-4
- swabs
  - cleaning, 3-5
- T**
- tag
  - service, 1-12, 4-3, 5-4
- temperature
  - affect on electrical performance, 2-2
  - calibration, 2-2
  - cautions about, 2-2
  - changes in, 2-2
  - device, 2-2
  - error-corrected, 2-2
  - measurement, 2-2
  - specifications, 2-2
  - operating, 2-2
  - storage, 2-2
  - verification and measurement, 2-2
- test configuration
  - one or two cables, 3-16
- test data, 4-3
- threads
  - connector
    - cleaning, 3-5
    - inspecting, 3-3
- tools
  - hex wrench, 1-9
  - part numbers, 6-3
  - spanner wrench, 1-9
  - torque wrench, 1-9
- torque wrench, 1-11
  - part number, 6-3
  - specifications, 3-13
- traceability
  - of device specifications, 4-2, 4-3
- TRL calibration
  - acronym meaning, 1-2
  - performing
    - 8510, 3-27
    - PNA, 872x, and 875x, 3-26
- troubleshooting, 5-2
- V**
- verification
  - temperature, 2-2
- visual inspection, 3-3
- W**
- wear

connector, 3-3  
  affect on electrical  
    performance, 3-3  
when to calibrate, 1-16  
wrench  
  open-end, 1-11, 3-14, 3-15  
  part number, 6-4  
  proper positioning of, 3-14  
  spanner  
    part number, 6-3  
  torque, 1-11, 3-13, 3-14  
    part number, 6-3  
    precautions for use of, 3-14  
    proper use of, 3-14  
wrist strap  
  part number, 6-4

## **Z**

zeroing  
  connector gage, 3-9, 3-11